



**DINAS SOSIAL
PROVINSI SUMATERA UTARA**

**UPT PELAYANAN SOSIAL ANAK
KABANJAHE-SIDIKALANG**

**PROYEK:
PERENCANAAN BANGUNAN PANTI ANAK SIDIKALANG
(UPT PELAYANAN SOSIAL ANAK SIDIKALANG-KABANJAHE)**

GAMBAR RENCANA



CV. PELITA BUANA

Address : Jalan Tuba II No. 58
www.pelita_buanacv@yahoo.com

TAHUN ANGGARAN 2023

DAFTAR ISI			DAFTAR ISI		
NO LBR	NAMA GAMBAR	SKALA	NO LBR	NAMA GAMBAR	SKALA
1	GROUND PLAN	1:150	24	DETAIL PONDASI MENERUS	1:20
2	DENAH	1:150	25	DETAIL PONDASI MENERUS & RAMP	1:20
3	TAMPAK A & B	1:150	26	DETAIL KOLOM TERAS & BAK TANAMAN	1:20
4	TAMPAK C & D	1:150	27	DENAH RENCANA SLOOF	1:150
5	POTONGAN A-A	1:100	28	DENAH RENCANA KOLOM	1:150
6	POTONGAN B-B	1:100	29	DENAH RENCANA BALOK LATEI	1:150
7	DENAH RENCANA POLA LANTAI	1:150	30	DENAH RENCANA BALOK TERAS	1:150
8	DENAH RENCANA KUSEN	1:150	31	DENAH RENCANA RING BALOK	1:150
9	DETAIL PINTU	1:20	32	DENAH RENCANA TULANGAN DAK	1:150
10	DETAIL PINTU	1:20	33	TABEL PEMBESIAN	NTS
11	DETAIL PINTU & JENDELA	1:20	34	DENAH INSTALASI AIR BERSIH	NTS
12	DETAIL JENDELA	1:20	35	DETAIL POMPA & TANGKI AIR	NTS
13	DETAIL JENDELA	1:20	36	DENAH INSTALASI AIR KOTOR & AIR BEKAS	NTS
14	DETAIL JENDELA	1:20	37	DIAGRAM INSTALASI PIPA AIR BEKAS DAN KOTOR, DETAIL SEPTIKTANK	NTS
15	DENAH RENCANA FINISHING DINDING EKSTERIOR	1:150	38	RENCANA TITIK LAMPU	NTS
16	DENAH RENCANA FINISHING DINDING INTERIOR	1:150	39	DIAGRAM SKEMATIK LISTRIK	NTS
17	DENAH RENCANA RANGKA PLAFOND	1:150	40	RENCANA STOP KONTAK	NTS
18	DENAH RENCANA PLAFOND	1:150	41	INSTALASI FIRE ALARM	NTS
19	DENAH RENCANA RANGKA ATAP	1:150	42	DIAGRAM SKEMATIK FIRE ALARM	NTS
20	DETAIL POTONGAN KUDA-KUDA	1:70	43	RENCANA CCTV	NTS
21	DETAIL POTONGAN KUDA-KUDA	1:70	44	DIAGRAM SKEMATIK INSTALASI CCTV	NTS
22	DENAH ATAP	1:150	45	RENCANA TATA UDARA	NTS
23	DENAH RENCANA PONDASI	1:150			

KETERANGAN

NO	TAMBAHAN	KETERANGAN	PIRAMP

REVISI

PEMBERI TUGAS



DINAS SOSIAL
PROVINSI SUMATERA UTARA
JALAN PONTIANAK NO. 100
KOTA MEDAN 20132
SUMATERA UTARA

MENYETUJUI

KEPALA DINAS SOSIAL
PROVINSI SUMATERA UTARA



PEKERJA PELAKSANA TEKNIK KEGIATAN



KEPALA KONSULTAN PERENCANA

CV. PELITA BUANA

TEAM LEADER



PERENCANAAN BANGUNAN
PANTI ANAK SEDIKALANG
(SUPT PELAYANAN SOSIAL ANAK
SEDIKALANG KABUPATEN)

TAHUN ANGGARAN 2023

JUDUL GAMBAR

DAFTAR ISI

NO GAMBAR	AD. PRATAMA	REVISI
001		
002		
003		
004		
005		
006		
007		
008		
009		
010		
011		
012		
013		
014		
015		
016		
017		
018		
019		
020		
021		
022		
023		
024		
025		
026		
027		
028		
029		
030		
031		
032		
033		
034		
035		
036		
037		
038		
039		
040		
041		
042		
043		
044		
045		
046		
047		
048		
049		
050		
051		
052		
053		
054		
055		
056		
057		
058		
059		
060		
061		
062		
063		
064		
065		
066		
067		
068		
069		
070		
071		
072		
073		
074		
075		
076		
077		
078		
079		
080		
081		
082		
083		
084		
085		
086		
087		
088		
089		
090		
091		
092		
093		
094		
095		
096		
097		
098		
099		
100		

CAD FILE

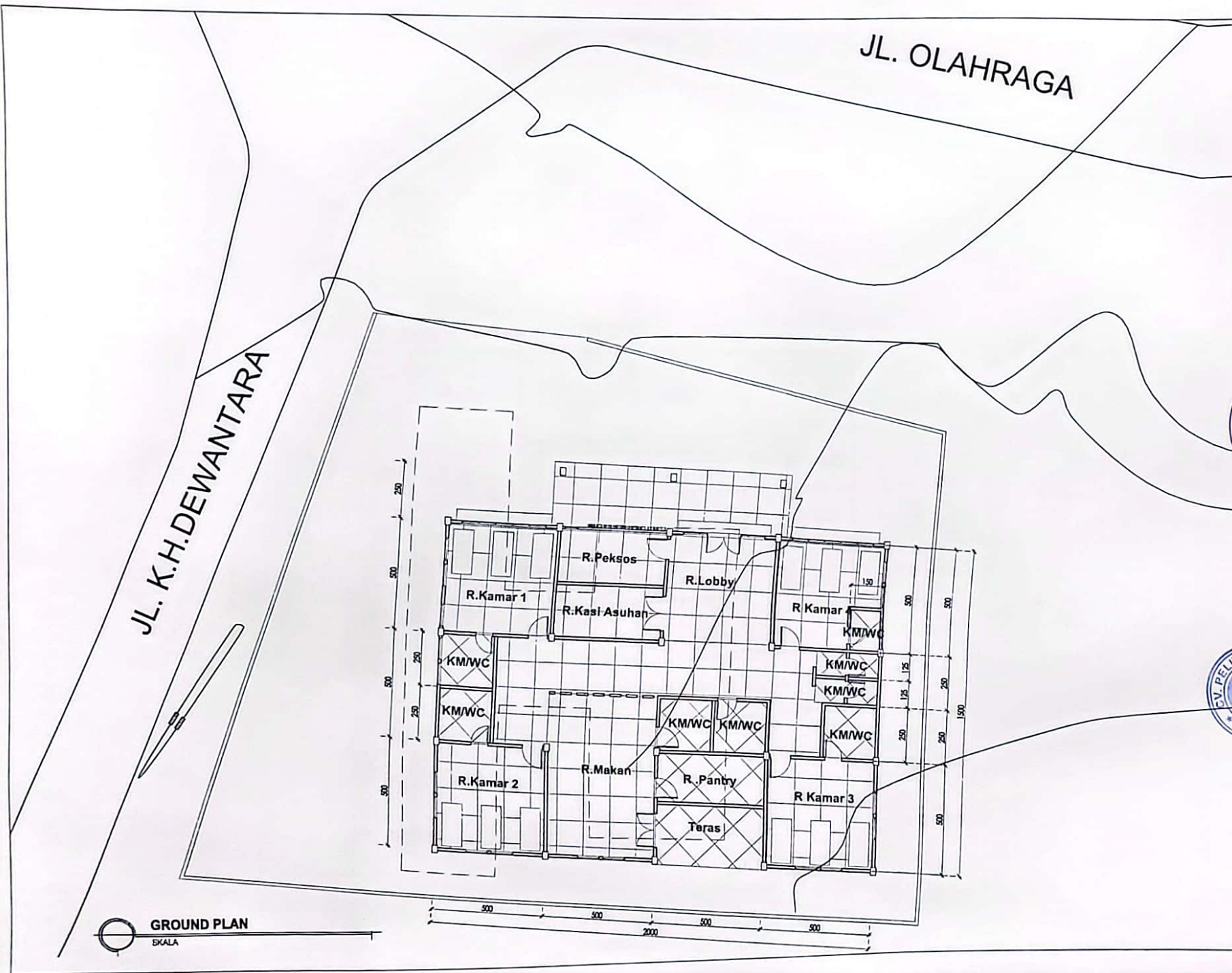

GROUND PLAN
SKALA

KETERANGAN		
NO	TANGGAL	KETERANGAN / REVISI
PEMBERI TUGAS		
 DINAS SOSIAL PROVINSI SUMATERA UTARA <small>UPT PELAYANAN SOSIAL ANAK SINGKALANG KASABAN</small>		
MENYETUJUI		
<small>KEPALA DINAS SOSIAL</small> <small>PEWANGKALAN SUMATERA UTARA</small>		
<small>DR. ELURANI PRINAHMAYATI S.Si, A.M, M.Si</small> <small>NIP. 196222119079132007</small>		
 <small>PELAKSANAAN BANGUNAN</small> <small>PERENCANAAN BANGUNAN</small> <small>PERENCANAAN BANGUNAN</small> <small>PERENCANAAN BANGUNAN</small>		
<small>KARLENDONG SINAGAH</small> <small>NIP. 197112120011007</small> <small>KONSULTAN PERENCANAAN</small>		
 <small>TEAM LEADER</small>		
 <small>PELITA BUANA</small> <small>PERENCANAAN BANGUNAN</small> <small>PERENCANAAN BANGUNAN</small> <small>PERENCANAAN BANGUNAN</small>		
<small>TAHUN ANGGARAN 2023</small> <small>JUDUL GAMBAR</small>		
GROUND PLAN		
<small>DI GAMBAR</small> <small>ADI PRATAMA</small>		
<small>DISERVISI</small> <small>SAPULU M. HADAR</small>		
<small>PELAYANAN</small> <small>UMUM</small>		
<small>SKALA</small> <small>1:100</small>		
<small>CAD FILE</small>		

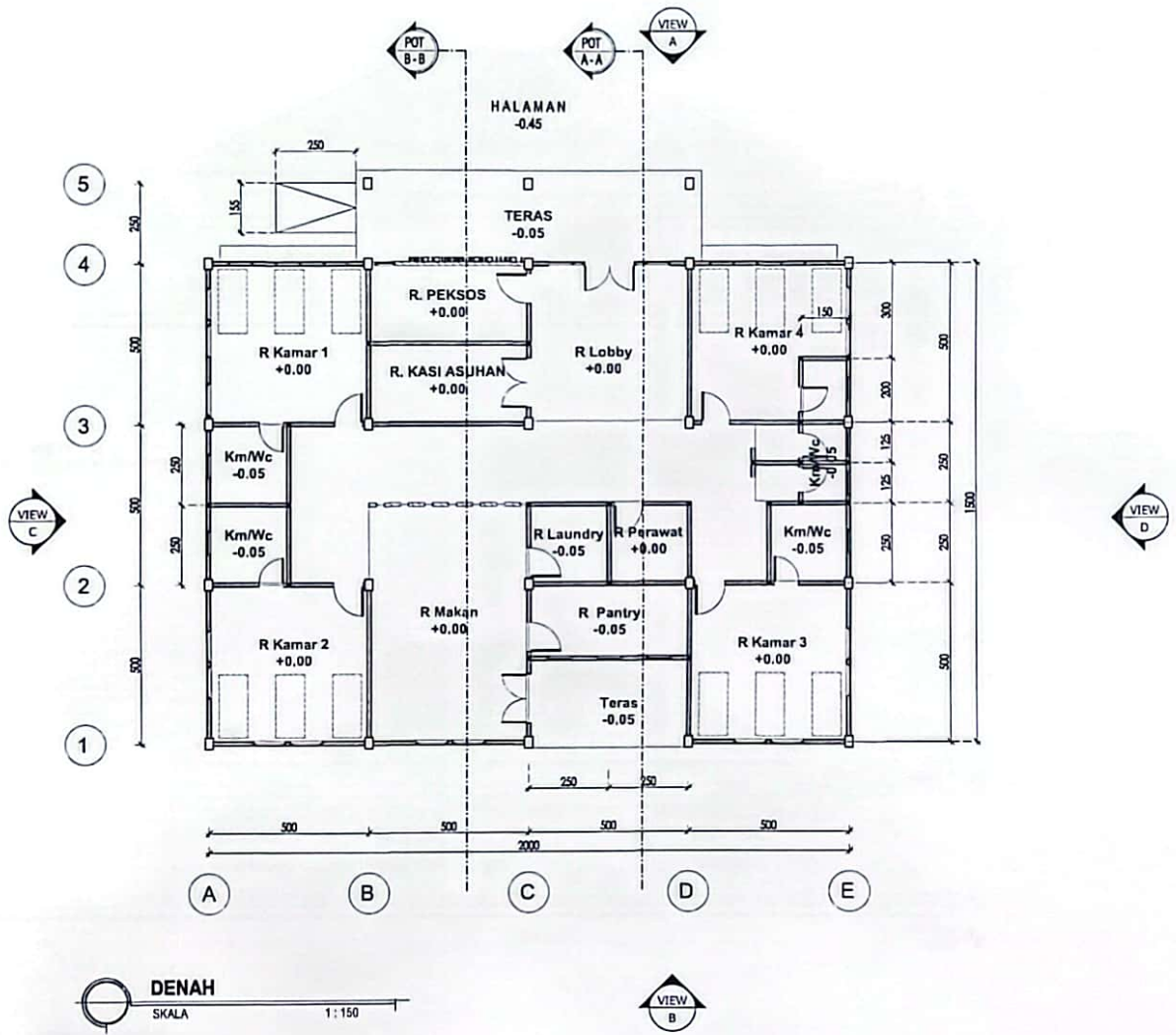

DENAH
SKALA 1:150

KETERANGAN		
NO	TAMBAH	REVISI
PEMBERU TUGAS		
 DINAS SOSIAL PROVINSI SUMATERA UTARA UPT PELAYANAN SOSIAL ANAK SISKALANG KABANJAH		
MENYETUJUI		
KEPALA DINAS SOSIAL PROVINSI SUMATERA UTARA		
DIREKTUR LAYANAN SOSIAL ANAK UPT PELAYANAN SOSIAL ANAK SISKALANG KABANJAH		
PEJABAT PELAKSANA TEKNIK KEGIATAN		
 F. MELINDA S. SIBAGA, ST NIP. 19711228 200811 1 001 FONSULTAN PERENCANAAN		
 CV. PELITA BUANA		
TEAM LEADER		
 CV. PELITA BUANA MEDIA		
KEGIATAN		
PERENCANAAN BANGUNAN PANTI ANAK SISKALANG (UPT PELAYANAN SOSIAL ANAK SISKALANG KABANJAH)		
TAHUN ANGGARAN 2023		
JUDUL GAMBAR		
DENAH		
DI GAMBAR	ADI PRATAMA	
DITREVISI	SARUL M. HASAN	2
PERUBAHAN		
SKALA	1:100	
CAD FILE		

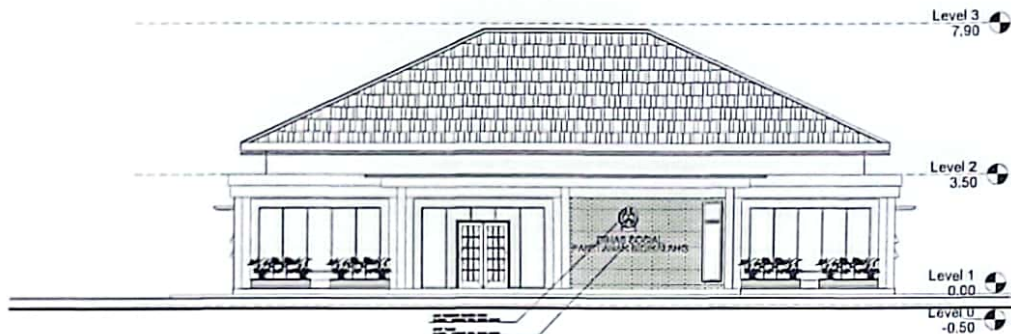

VIEW - A
SKALA 1 : 150



VIEW - B
SKALA 1 : 150

KETERANGAN		
NO	TANGGAL	KETERANGAN / REVISI
PEMBERI TUGAS		
 DINAS SOSIAL PROVINSI SUMATERA UTARA UPT PELAYANAN SOSIAL ANAK SIKALANG-KABANGJAHE		
MENYETUJUI		
KEPALA DINAS SOSIAL PROVINSI SUMATERA UTARA		
ZULI SILIRANI PURNAMA WATI S. SI. APM. M. SI. NIP. 14071271201732001		
 S. DENY ELISKA S. T. A. NIP. 140715121400173001 MEDIS KEHUT PEJABAT PELAKSANA TEKNIS KEGIATAN		
 KADIS SOSIAL SIKALANG NIP. 14071524200011001		
KONSULTAN PERENCANA		
 CV. PELITA BUANA Medan, Sumatera Utara 2018		
TEAM LEADER		
 RAFFAN R. LUBIS ST		
KEGIATAN		
PERENCANAAN BANGUNAN PANTI ANAK SIKALANG (UPT PELAYANAN SOSIAL ANAK SIKALANG-KABANGJAHE)		
TAHUN ANGGARAN 2023		
JUDUL GAMBAR		
TAMPAK A & B		
DI GAMBAR	ADI PRATAMA	MONITORING GAMBAR
DIREKSI	SAIFUL M. HASAN	
DISENJAHI		3
UNTILAH		
SKALA	1:100	
CAD FILE		

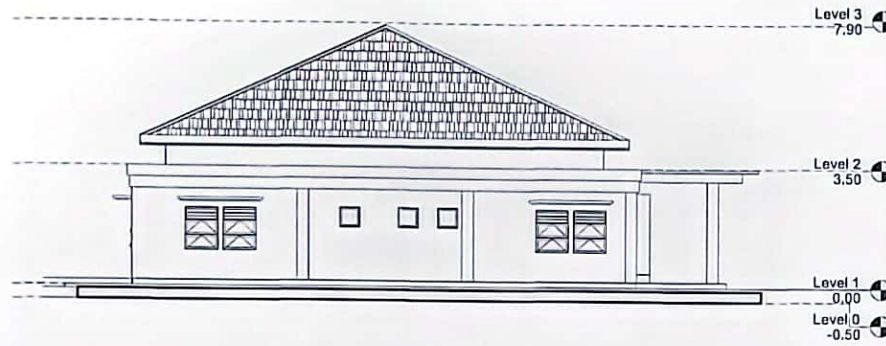

VIEW - C
SKALA 1:150



VIEW - D
SKALA 1:150

KETERANGAN

NO	TAYOGAL	KETERANGAN	PURAF

REVISI

PEMERIKSA TUGAS

**DINAS SOSIAL
 PROVINSI SUMATERA UTARA**
 UPT PELAYANAN SOSIAL ANAK
 SIDIKALANG KABANJAHIE

MENYETUJUI
 KEPALA DINAS SOSIAL
 PROVINSI SUMATERA UTARA

DR. SUHANI PUJUNAMA WATI S. ST. Ag. M. Ed.
 NIP. 197103101980001001



PEJABAT PELAKSANA TEK. VIS. KEGIATAN

KARLELINDA Sihalaga SH
 NIP. 197112282008311001

KONSULTAN PERENCANA

CV. PELITA BUANA
 Jalan ...

TEAM LEADER

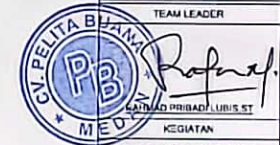

KEGIATAN

PERENCANAAN BANGUNAN
 PANTI ANAK SIDIKALANG
 (UPT PELAYANAN SOSIAL ANAK
 SIDIKALANG KABANJAHIE)

TAHUN ANGGARAN 2023

JUDUL GAMBAR

TAMPAK C & D

DI GAMBAR | ADI PRATAMA | 

DIPERIKSA | SAHUL M. HASAN | 

SKALA 1:150

4

CAO FILE

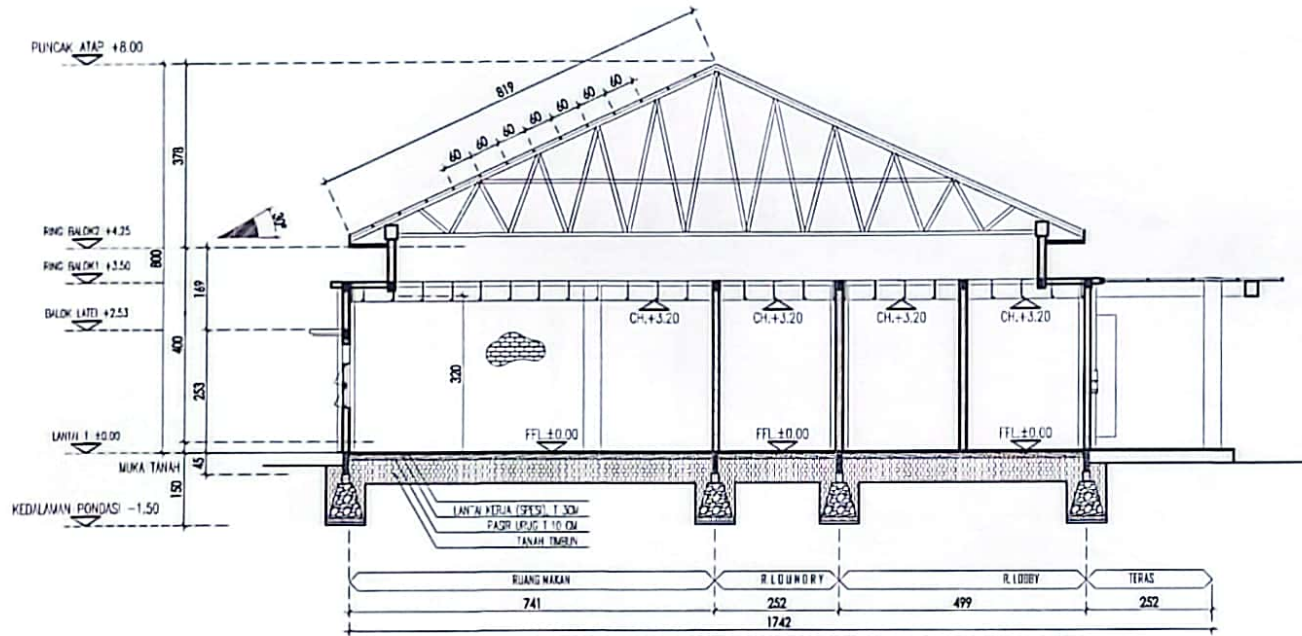

POTONGAN A - A
SKALA 1 : 100

KETERANGAN

NO	TANGGAL	KETERANGAN	PIKUP
REVISI			

PEMBERI TUGAS

DINAS SOSIAL
PROVINSI SUMATERA UTARA
UPT PELAYANAN SOSIAL ANAK
SIDIKALANG KABANJAHIE
MENYETUJUI
KEPALA DINAS SOSIAL
PROVINSI SUMATERA UTARA



MOH. GETAHU
PEJABAT PELAKSANA TEKNIK KEGIATAN
KARLETONA S. SINAGA S.H.
NIP. 19711228 200301 1 001
KONSULTAN PERENCANA

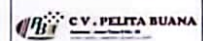

TEAM LEADER



KEGIATAN
PERENCANAAN BANGUNAN
PANTI ANAK SIKALANG
(UPT PELAYANAN SOSIAL ANAK
SIDIKALANG KABANJAHIE)

TAHUN ANGGARAN 2023
JUDUL GAMBAR

POTONGAN A-A

DI GAMBAR	ACI PRATAMA	
DIREKSIAN	SAIFUL M. HASAN	
DISENTEKSI		5
PEREGARAHAN		
UNTUK		
SKALA	1:100	
EAD FILE		

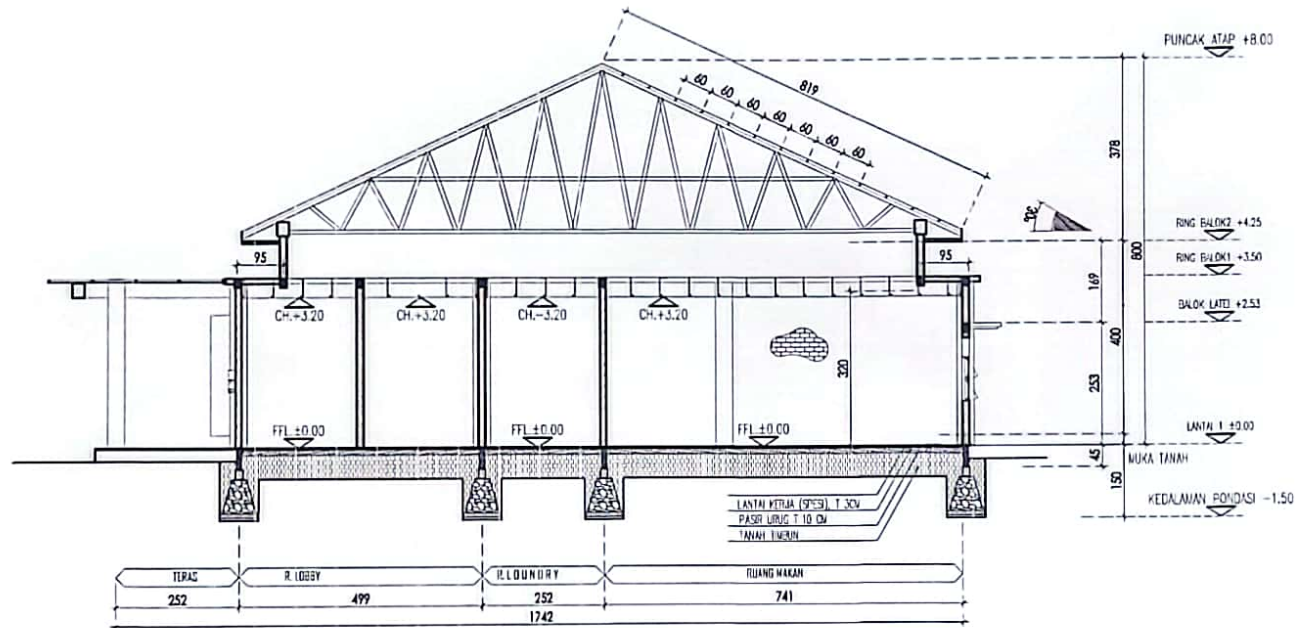

POTONGAN B - B
SKALA 1 : 100

KETERANGAN		
NO	FUNGSI	REVISI
PEMBERI TUGAS		
 DINAS SOSIAL PROVINSI SUMATERA UTARA <small>UPP PELAYANAN SOSIAL ANAK SISKALANG KABANJAH</small>		
MENYETUJUI		
KEPALA DINAS SOSIAL PROVINSI SUMATERA UTARA		
<small>DR. YULIANI PURNAMA NATI S. S. S. APR. M. S.</small> <small>0212 2 801 200</small>		
		
MENGETAHUI		
PEABAT PELAKSANA TEKNIS KEGIATAN  <small>KAPRI E. H. S. SINAGA, S.T.</small> <small>NIP. 19711229 2 0001 1 002</small>		
KONSULTAN PERENCANA		
		
TEAM LEADER		
		
KEGIATAN		
PERENCANAAN BANGUNAN PANTI ANAK SISKALANG <small>(UPP PELAYANAN SOSIAL ANAK SISKALANG KABANJAH)</small>		
TAHUN ANGGARAN 2023		
JL. DUL. GAMBAR		
POTONGAN B-B		
DIGAMBAR	ADRI PRATAWA	PROJEKSI
DIREVISI	SAFELI M. F. ALAN	PROJEKSI
DITAMBAH		
DITAMBAH		
SKALA	1:100	
EAD FILE		

HALAMAN
-045

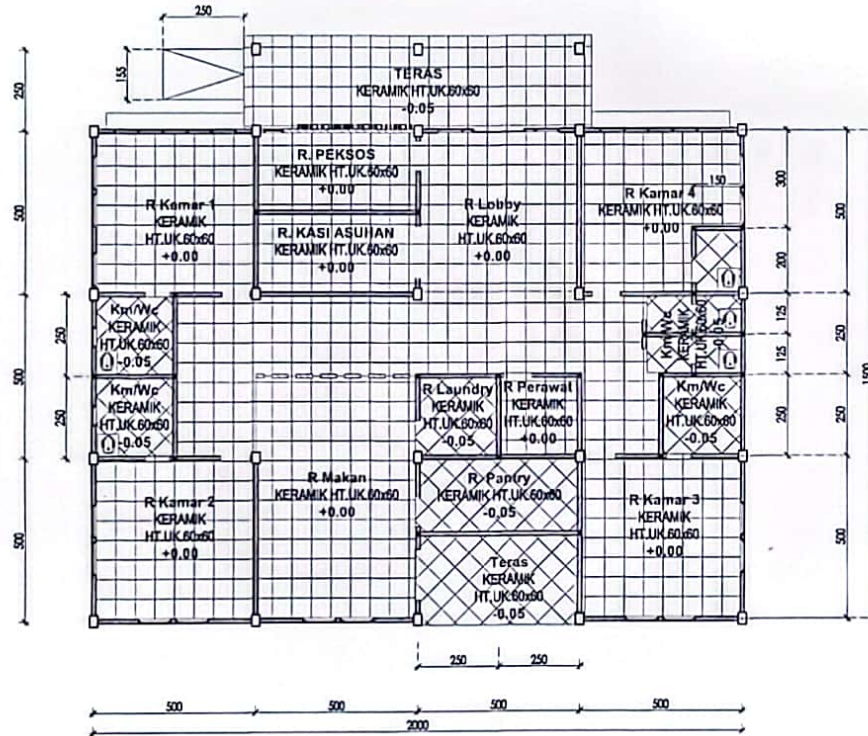

DENAH RENCANA POLA LANTAI
SKALA 1:150

KETERANGAN

NO	TANGGAL	KETERANGAN	PRUPAK

REVISI

PEMBERI TUGAS

**DINAS SOSIAL
PROVINSI SUMATERA UTARA**
UPT PELAYANAN SOSIAL ANAK
SINGKALANG KABANJAHAE

MENYETUJUI

PEPALA DINAS SOSIAL
PROVINSI SUMATERA UTARA

DR. SURBANI BERNANJALATI S. Si. Apt. M. Si.
NIP. 19671207 199703 2 001



MENGETAPUHI

PEJABAT PELAKSANA TUGAS KEGIATAN

[Signature]

KARLINGTONUS SINAGAH
NIP. 19711228 200001 1 001

KONSULTAN PERENCANA

C.V. PELITA BUANA

TEAM LEADER



KEGIATAN

PERENCANAAN BANGUNAN
PANTI ANAK SINGKALANG
(UPT PELAYANAN SOSIAL ANAK
SINGKALANG KABANJAHAE)

TAHUN ANGGARAN 2023

JUDUL GAMBAR

DENAH RENCANA
POLA LANTAI

DI GAMBAR	AID PRATAMA	<i>[Signature]</i>
-----------	-------------	--------------------

DIPERIKSA/DITETAPUHI	SAIFUL MAHALAN	
----------------------	----------------	--

PERENCANAAN	UNTUK	7
-------------	-------	---

SKALA	1:150	
-------	-------	--

CAD FILE

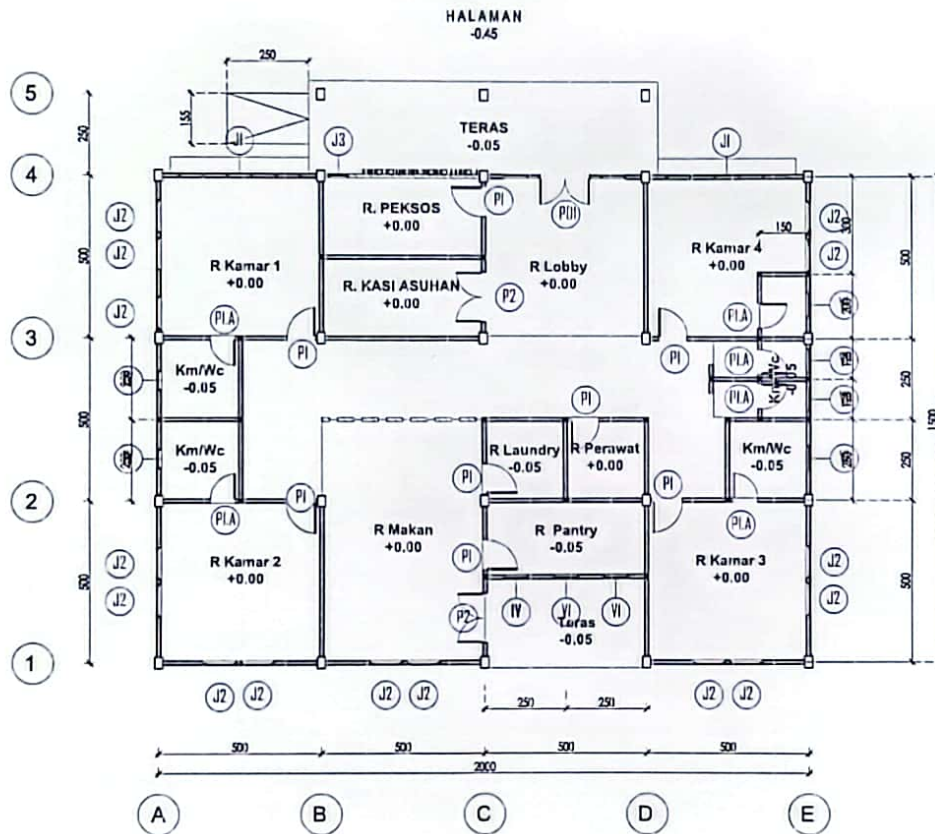

DENAH RENCANA KUSEN
SKALA 1 : 150

KETERANGAN		
NO	TANGGAL	REVISI
	KETERANGAN	PINDA
REVISI		
PEMBERI TUGAS		
<p style="text-align: center;">DINAS SOSIAL PROVINSI SUMATERA UTARA UPT PELAYANAN SOSIAL ANAK SID KALANG KABANGJAH</p>		
MENYETUJAI		
<p style="text-align: center;">KEPALA DINAS SOSIAL PROVINSI SUMATERA UTARA</p>		
<p style="text-align: center;">PRI SULBRA UT PERINAWATI, S. Si, Apt, M. Si. NIP. 19670217 2010031 001</p>		
<p style="text-align: center;">KEPALA</p>		
<p style="text-align: center;">DINAS SOSIAL PROVINSI SUMATERA UTARA UPT PELAYANAN SOSIAL ANAK SID KALANG KABANGJAH 19670217 2010031 001</p>		
MENGETAHUI 1		
PEKABAR PELAKSANA/KELOMPOK KESEHATAN		
<p style="text-align: center;">KARLENDON LIS SINAGA, SH NIP. 19711219 200301 1 001</p>		
KONSULTAN PERENCANA		
<p style="text-align: center;">C.V. PELITA BUANA</p>		
TEAM LEADER		
<p style="text-align: center;">C.V. PELITA BUANA REJANG BANGSI BARU KABUPATEN SIDIKALANG SUMATERA UTARA 19730414 199906 1 001</p>		
<p style="text-align: center;">DIPERIKSA DAN DISAHKANKAN</p>		
<p style="text-align: center;">PENCANAAN BANGUNAN PANTI ANAK SIDIKALANG (UPT PELAYANAN SOSIAL ANAK SID KALANG KABANGJAH)</p>		
TAHUN ANGGARAN 2023		
JUDUL GAMBAR:		
<p style="text-align: center;">DENAH RENCANA KUSEN</p>		
DI GAMBAR	ACU PRATAMA	
DISKRIPSI	SAPUL M HASAN	
TELUKAN	MINTU	
JUAL		
CAD FILE		

Ringk' ACP RANCA
FURING JUMBO

25
45
205

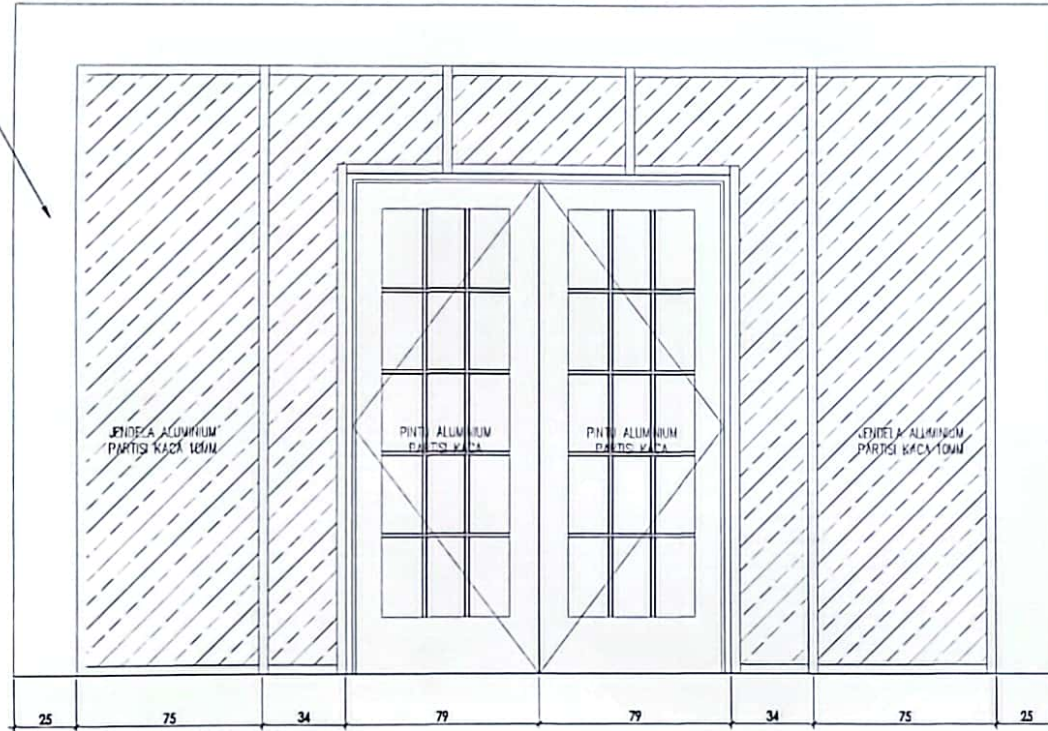

BALOK LATEI 15x11
KACA 10MM
PINTU ALUMINIUM MOTIF KAYU

15

15

50

203

208

210

SISI DALAM

SISI LUAR

PERUKAAN LANTAI
+0.00

SELASAR
-0.05

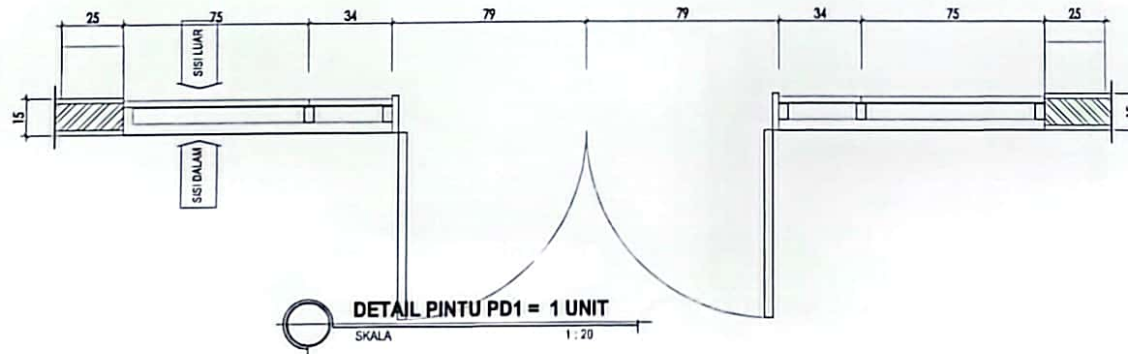

DETAIL PINTU PD1 = 1 UNIT

SKALA

1 : 20

KETERANGAN

NO. TANGGAL KETERANGAN PERUB

REVISI

PEMBERI TUGAS



DINAS SOSIAL
PROVINSI SUMATERA UTARA

UPF PELAYANAN SOSIAL ANAK
SINGKALANG-KABANGKALU

MENYETUJUI

KEPALA DINAS SOSIAL
PROVINSI SUMATERA UTARA

SRI SURIANI PURNAMA WATI S. SI. AM. M. SI.

NIP. 19671207 198703 2 001



MENGETAHUI

PEKERJA PELOPOR TEKNIK KEGIATAN

[Signature]

KARL ESKONDISI SINAGA, ST.

NIP. 19870204 200601 1 001

KONSULTAN PERENCANA

CV. PELITA BUANA

TEAM LEADER



PERENCANAAN BANGUNAN

PANTI ANAK SINGKALANG

(UPF PELAYANAN SOSIAL ANAK

SINGKALANG-KABANGKALU)

TAHUN ANGGARAN 2023

JUDUL GAMBAR

DETAIL PINTU

DI GAMBAR ADI PRATAMA

DIPERIKSA/SAFUL M. HALAN

PERILAKUAN LANTAI

SKALA 1:20

END FILE

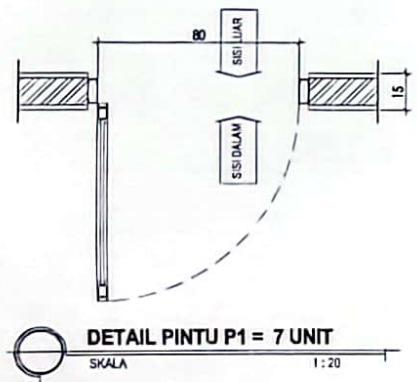
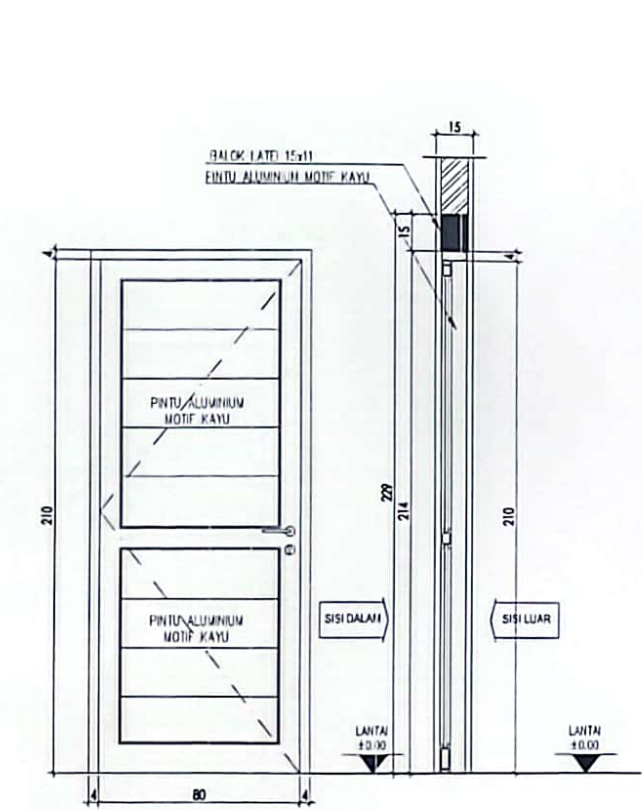

DETAIL PINTU P1 = 7 UNIT
SKALA 1 : 20

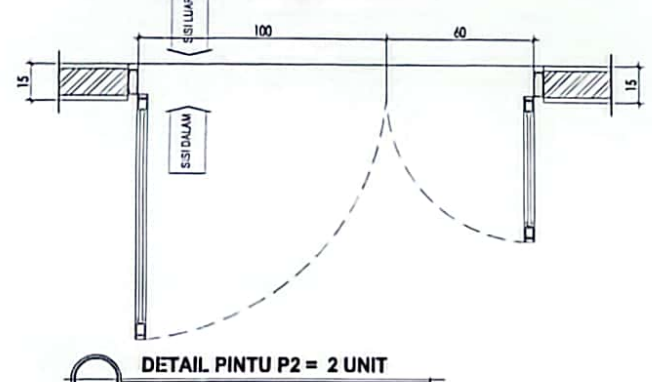
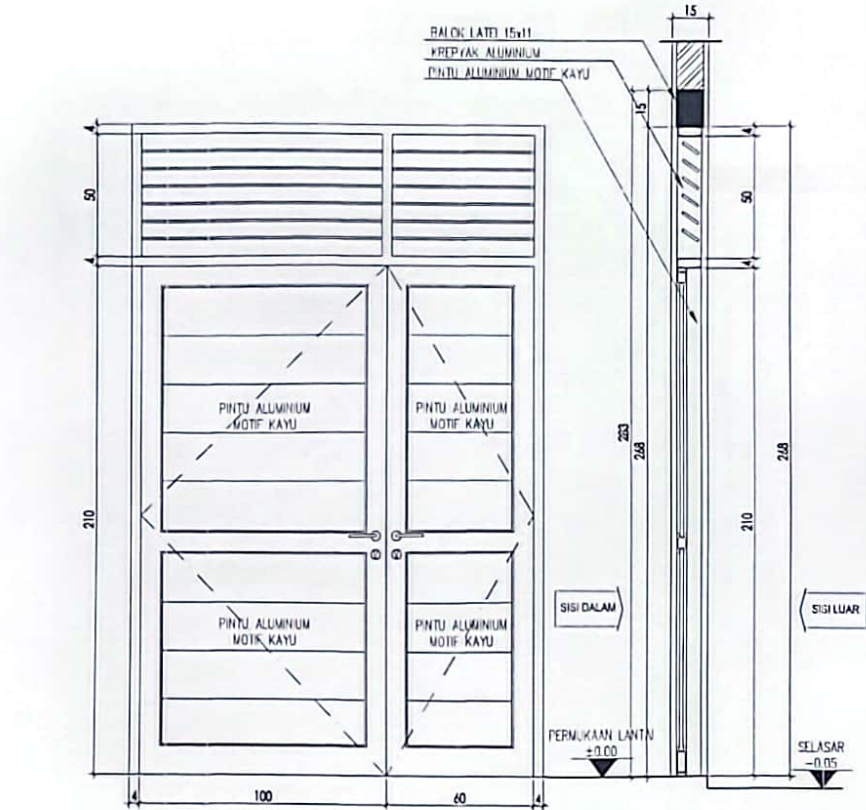

DETAIL PINTU P2 = 2 UNIT
SKALA 1 : 20

KETERANGAN

NO	REVISI	REVISI	REVISI
1			
2			
3			
4			
5			
6			
7			
8			
9			
10			
PEMBETU TUGAS			
 DINAS SOSIAL PROVINSI SUMATERA UTARA UPT PELAYANAN SOSIAL ANAK SIKALANG KABUPATEN			
MENYETUJUI			
KEPALA DINAS SOSIAL PROVINSI SUMATERA UTARA			
DIREKTUR PELAYANAN SOSIAL ANAK SIKALANG KABUPATEN			
 MENGETAHUI PEJABAT PELAKSANA TIENS KEGIATAN			
 KARL E. SINAGA, S.T. NIP. 19711225 200301 1 001 KONSULTAN PERENCANA			
 C.V. PELITA BUANA TEAM LEADER			
 PELITA BUANA PERENCANAAN BANGUNAN PANTI ANAK SIKALANG (UPT PELAYANAN SOSIAL ANAK SIKALANG KABUPATEN) MHE			
TAHLUN ANGGARAN 2023			
JUDUL GAMBAR			
DETAIL PINTU			
LE GAMBAR	ADI PRITAMA		
DISERVISI	SAIFUL M. HASAN		
REVISI			
NO			
1			
2			
3			
4			
5			
6			
7			
8			
9			
10			
11			
12			
13			
14			
15			
16			
17			
18			
19			
20			
21			
22			
23			
24			
25			
26			
27			
28			
29			
30			
31			
32			
33			
34			
35			
36			
37			
38			
39			
40			
41			
42			
43			
44			
45			
46			
47			
48			
49			
50			
51			
52			
53			
54			
55			
56			
57			
58			
59			
60			
61			
62			
63			
64			
65			
66			
67			
68			
69			
70			
71			
72			
73			
74			
75			
76			
77			
78			
79			
80			
81			
82			
83			
84			
85			
86			
87			
88			
89			
90			
91			
92			
93			
94			
95			
96			
97			
98			
99			
100			

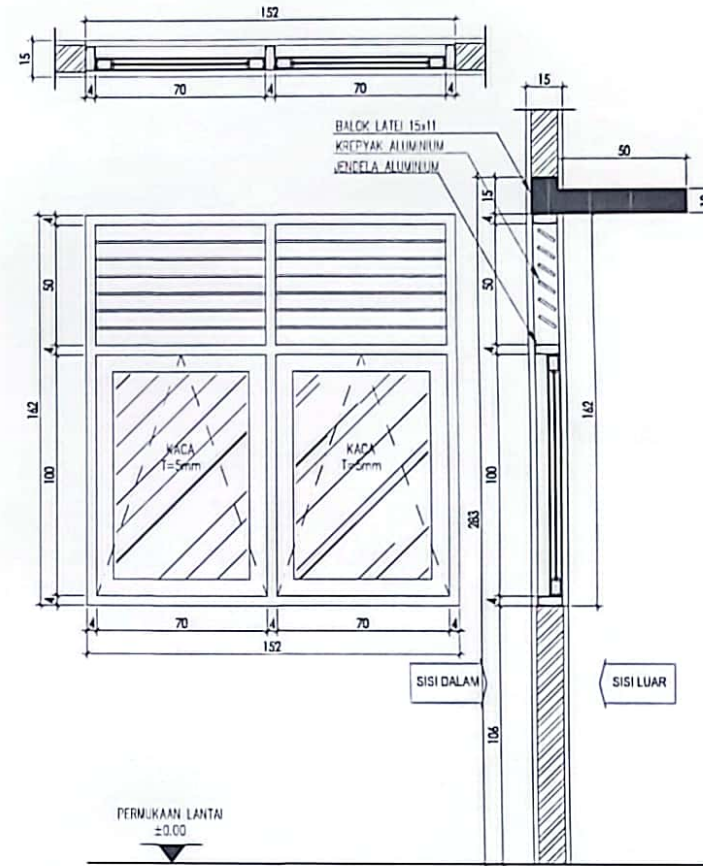
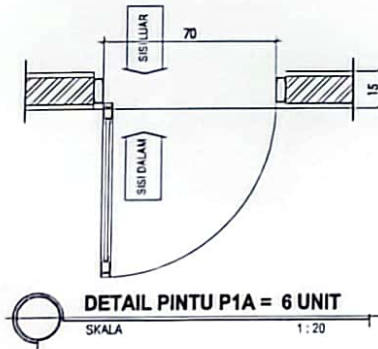
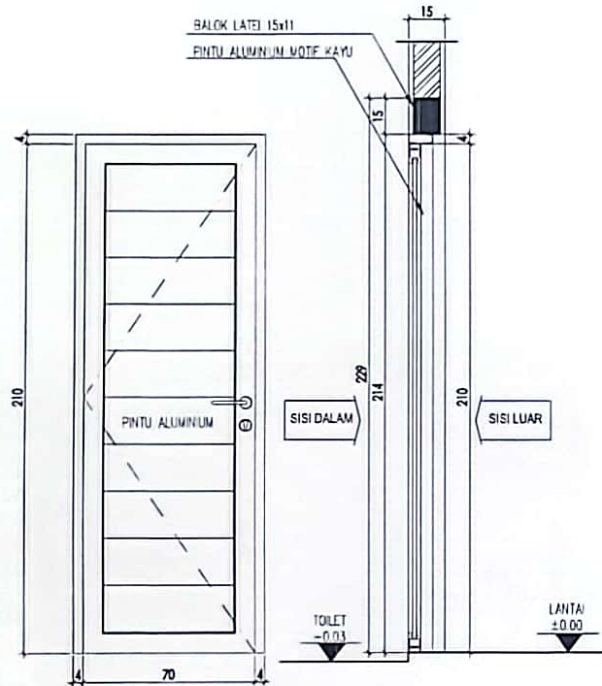

DETAIL JENDELA J2 = 7 UNIT
SKALA 1:20

KETERANGAN

NO	TANGGAL	REVISI	REVISI	REVISI

PEMBERI TUGAS

**DINAS SOSIAL
PROVINSI SUMATERA UTARA**
UPT PELAYANAN SOSIAL ANAK
SINGKALANG KABANJAH

MENYETUJUI
KEPALA DINAS SOSIAL
PROVINSI SUMATERA UTARA



PEJABAT PELAKSANA KEGIATAN
KARL EDY PRATIWI SUNAGA, ST
19711201200011001
KONSULTAN PERENCANA

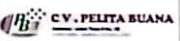

TEAM LEADER



PERENCANAAN BANGUNAN
PANTI ANAK SINGKALANG
(UPT PELAYANAN SOSIAL ANAK
SINGKALANG KABANJAH)

TAHUN ANGGARAN 2023

JUDUL GAMBAR

DETAIL PINTU & JENDELA

DI GAMBAR	ADI PRATAMA		
DIPERIKSA/DIKONTROL	SAFUL M HASAN		
PERENCANAAN			
UNIT UK			11
SKALA	1:20		
CAD FILE			

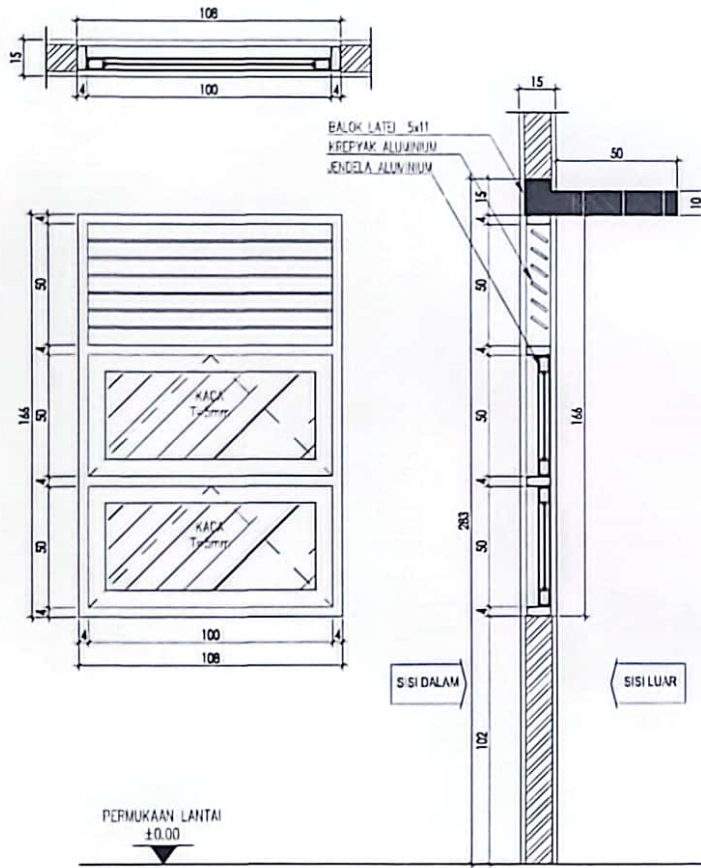

DETAIL JENDELA J2A = 15 UNIT
SKALA 1:20

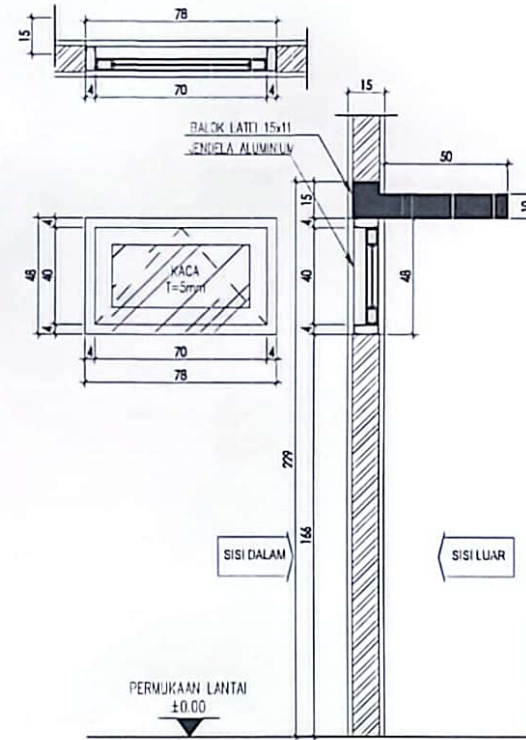

DETAIL VENTILASI V1 = 6 UNIT
SKALA 1:20

KETERANGAN		
NO	TANGGAL	KETERANGAN
REVISI		
PEMERIKSA TUJAS		
 DINAS SOSIAL PROVINSI SUMATERA UTARA <small>UPY PELAYANAN SOSIAL ANAK</small> <small>SIDIKALANG KABUPATEN</small>		
MENYETUJUI		
KEPALA DINAS SOSIAL		
PROVINSI SUMATERA UTARA		
<small>DR. SULISANI PURNAMA/ATI S. ST. Apt. M. Si</small> <small>NIP. 19871207 199703 2 001</small>		
 <small>KABUPATEN SIDIKALANG</small> <small>KESETARAAN</small>		
PENANJANG PELAYANAN TENAGA KEGIATAN		
 <small>KARLETHICUS SINAGA, SH</small> <small>NIP. 19711228 200011 1 001</small>		
KONSULTAN PERENCANA		
 CV. PELITA BUANA <small>Perencana Bangunan</small>		
TEAM LEADER		
 <small>R. Pradana</small> <small>RAHMAD PRADANA LUBIS, ST</small> <small>KEGIATAN</small>		
PERENCANAAN BANGUNAN		
PANTI ANAK SIDIKALANG		
(UPY PELAYANAN SOSIAL ANAK		
SIDIKALANG KABUPATEN)		
TAHUN ANGGARAN 2023		
JUDUL GAMBAR		
DETAIL JENDELA		
DI GAMBAR	ADI PRATAMA	12
DISERVISI	SAIFUL M. HASAN	
PERENCANA		
UNTUK		
SKALA	1:20	
CAD FILE		

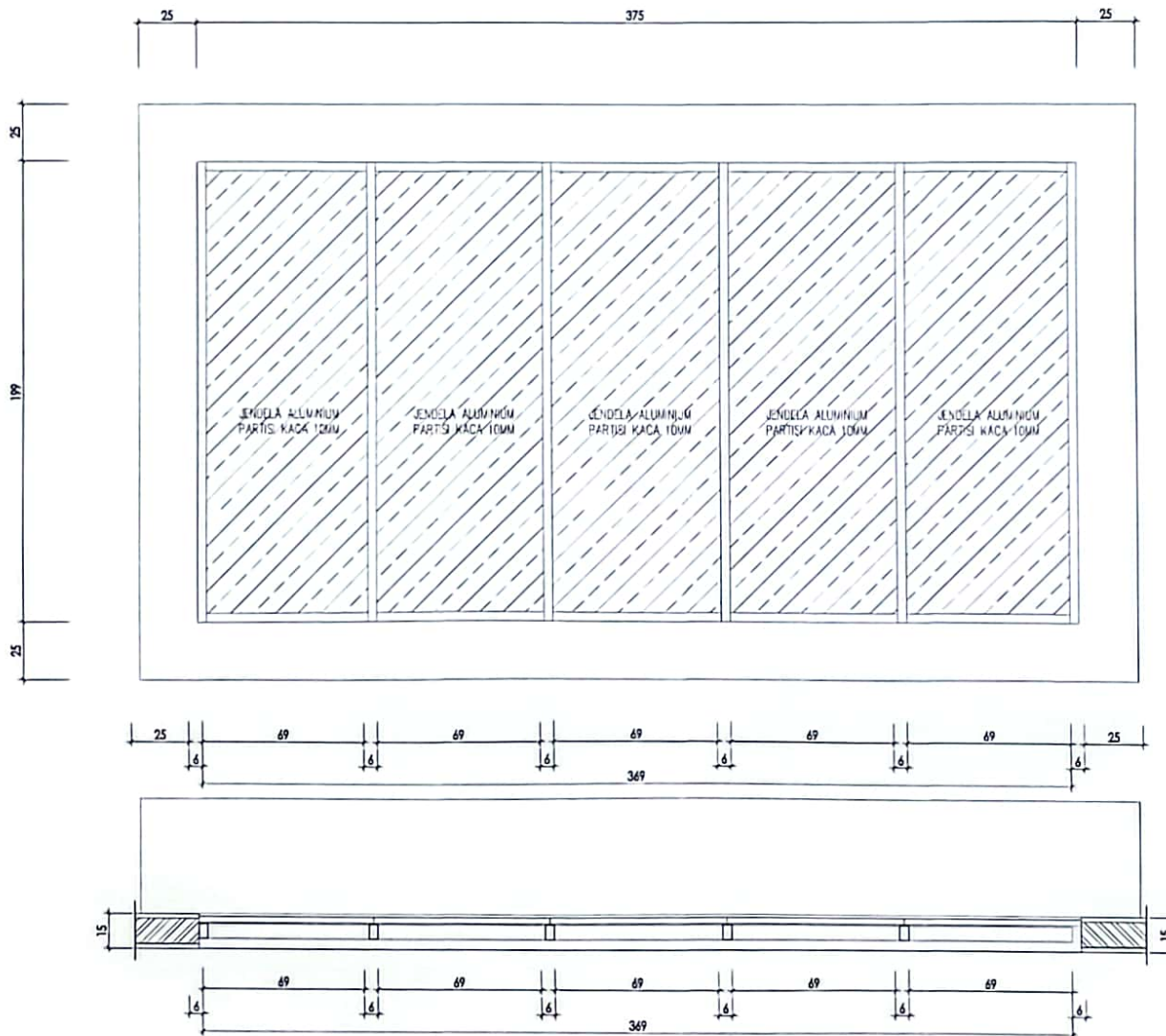

DETAIL JENDELA J1 = 2 UNIT
SKALA 1:20

KETERANGAN		
NO	TAMBAH	KETERANGAN
REVISI		
PEMBERI TUGAS		
 DINAS SOSIAL PROVINSI SUMATERA UTARA UPT PELAYANAN SOSIAL ANAK SIKALANG KABANJAHE		
MENYETUJUI		
KEPALA DINAS SOSIAL PROVINSI SUMATERA UTARA		
PRI SURILANI PERJANAMAUATI S. S. A. M. S. NIP. 19671207 198703 2 001		
 KEPALA DINAS SOSIAL PROVINSI SUMATERA UTARA		
KARLEKIONUS SINAGA, S.H. NIP. 19711228 200801 1 001 KONSULTAN PERENCANA		
 CV. PELTA BUANA BANGUNAN PERENCANAAN		
TEAM LEADER		
 Rahnal BANGUNAN PERENCANAAN		
PERENCANAAN BANGUNAN PANTI ANAK SIKALANG (UPT PELAYANAN SOSIAL ANAK SIKALANG KABANJAHE)		
TAHUN ANGGARAN 2023		
JUDUL GAMBAR		
DETAIL JENDELA		
DI GAMBAR	ACI PRATAMA	
DIREKSI	ENFUS M. HASAN	
PERENCANAAN		
UNTUK		
SKALA	1:20	13
END FILE		

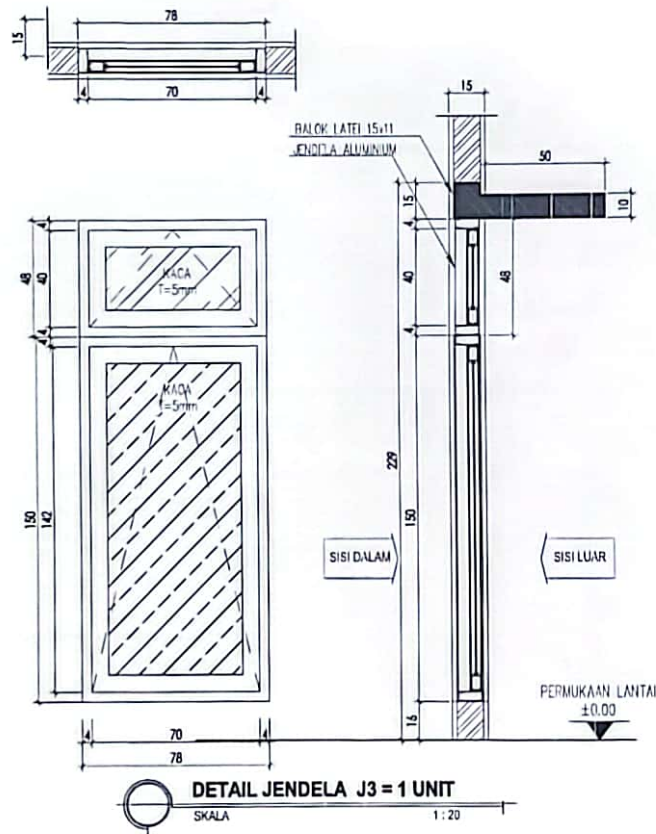

KETERANGAN		
NO	TAMBAHAN	REVISI
PEMBERI TUGAS		
 DINAS SOSIAL PROVINSI SUMATERA UTARA UPT PELAYANAN SOSIAL ANAK SIKHALANG KASABANJAHAI		
MENYETUJUI		
KEPALA DINAS SOSIAL PROVINSI SUMATERA UTARA		
DR. S. IRANI PURNAMA WATI, S. ST., M. M. S. NIP. 11 871 207 19 1903 2 001		
MENGECERAHJI		
 KEPALA DINAS SOSIAL ANAK SIKHALANG KASABANJAHAI		
KARYAWAN PELAYANAN SOSIAL ANAK SIKHALANG KASABANJAHAI NIP. 11 871 207 19 1903 2 001		
KONSULTAN PERENCANA		
 TEAM LEADER		
 RAFIQ NIP. 11 871 207 19 1903 2 001		
PERENCANAAN BANGUNAN PANTI ANAK SIKHALANG (UPT PELAYANAN SOSIAL ANAK SIKHALANG KASABANJAHAI)		
TAHUN ANGGARAN 2023		
JUDUL GAMBAR		
DETAIL JENDELA		
DI GAMBAR	ADI PRATAMA	
DIPERIKSA	SAIFUL M. HASAN	
DITETAPKAN		
UNTUK		14
SKALA	1:20	
CAD FILE		

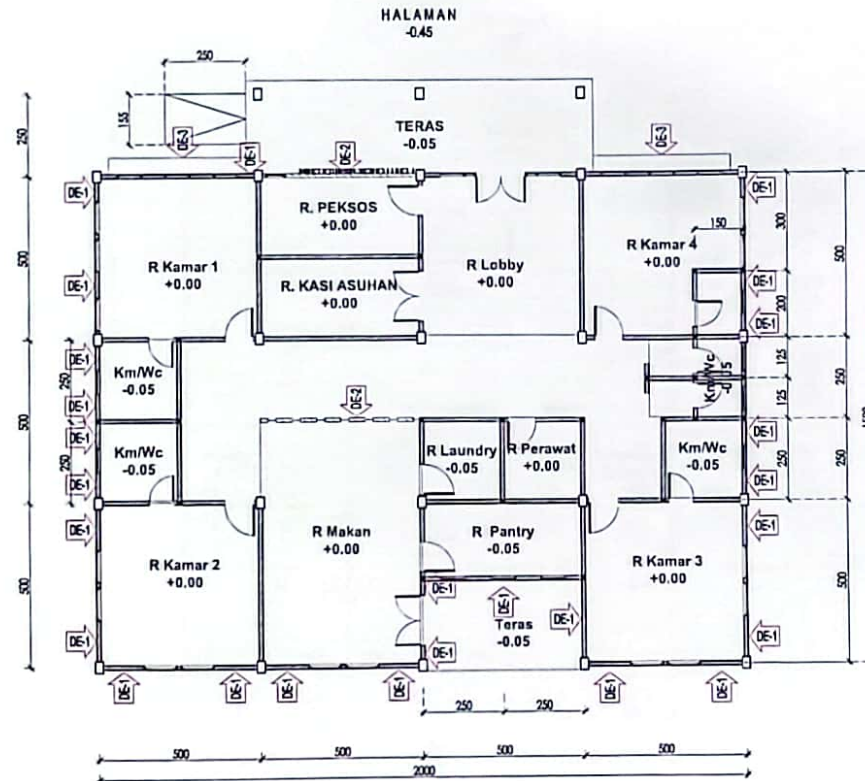

DENAH RENC. FINISHING DINDING EKSTERIOR
 SKALA 1:150

- KETERANGAN :
- DE-1 DINDING EKSTERIOR - PAS.BATA, FINISHING CAT WARNA....
 - DE-2 DINDING EKSTERIOR - PAS.BATA, FINISHING BATU BATA EKSPOS
 - DE-3 DINDING EKSTERIOR - PAS.BATA, FINISHING ACP RANGKA FURING JUMBO

KETERANGAN		
NO	TANGGAL	REVISI
PEMBERI TUGAS		
 DINAS SOSIAL PROVINSI SUMATERA UTARA <small>UPT PELAYANAN SOSIAL ANAK SIKKALANG KABARJAHNE</small>		
MENYETUJUI		
KEPALA DINAS SOSIAL PROVINSI SUMATERA UTARA		
<small>DR. SURIANI PURNAMA WATI S. SI, APT, M.Si NIP. 19671227 1 0013 2 001</small>		
MENGETAHUI		
KEPALA UPT PELAYANAN SOSIAL ANAK		
 <small>UPT PELAYANAN SOSIAL ANAK SIKKALANG KABARJAHNE</small>		
MENGETAHUI		
PELAKSANA KEGIATAN		
<small>KARENDING, D. SINACATH NIP. 19711229 200801 1 001</small>		
KONSULTAN PERENCANA		
 C.V. PELITA BUANA <small>Perencana Bangunan</small>		
TEAM LEADER		
 <small>SAHAJA, S. S.</small>		
KEGIATAN		
PERENCANAAN BANGUNAN PANTI ANAK SIKKALANG (UPT PELAYANAN SOSIAL ANAK SIKKALANG KABARJAHNE)		
TAHUN ANGGARAN 2023		
JUDUL GAMBAR		
DENAH RENCANA FINISHING DINDING EKSTERIOR		
DI GAMBAR	ADI PRATAMA	A
DIPERIKSA	SAIFUL M. HASAN	15
PERALOKAN UNTUK		
SKALA	1:150	
CAD FILE		

KETERANGAN :
 D-1 DINDING INTERIOR
 - PAS.BATA, FINISHING CAT WARNA...

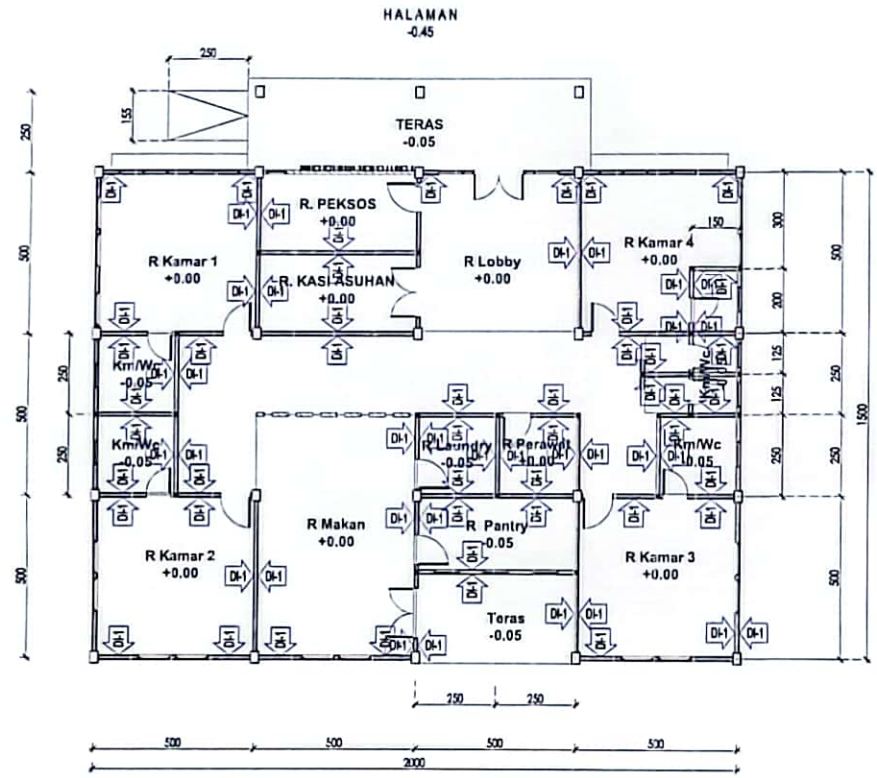

SKALA 1:150
 DENAH RENC. FINISHING DINDING INTERIOR

KETERANGAN		
NO	TANGGAL	KETERANGAN
REVISI		
PEMBERI TUGAS		
 DINAS SOSIAL PROVINSI SUMATERA UTARA UPT PELAYANAN SOSIAL ANAK SIKKALANG KAS ENJAH		
MENYETUJUI		
KEPALA DINAS SOSIAL PROVINSI SUMATERA UTARA		
DR. SILVANI PURNAMADEWATI S. S. S. S. S. NIP. 19671207 198903 2 001		
 PEJABAT PELAKSANA KEPENDAHWAHARAN		
KARYA EKSPERDISI S. NALGA, P. NIP. 19811228 200601 1 001 KONSULTAN PERENCANA		
 TEAM LEADER		
 KEGIATAN		
PERENCANAAN BANGUNAN PANTI ANAK SIKKALANG (UPT PELAYANAN SOSIAL ANAK SIKKALANG KAS ENJAH)		
TAMBAH ANGGARAN 2023		
JULIUL GAMBAR		
DENAH RENCANA FINISHING DINDING INTERIOR		
DI GAMBAR	AZI PRATAMA	
DIPERIKSA	SAPUL M. HAJARI	
DI RENCANA	UNTUK	
SKALA	1:150	18
EAD FILE		

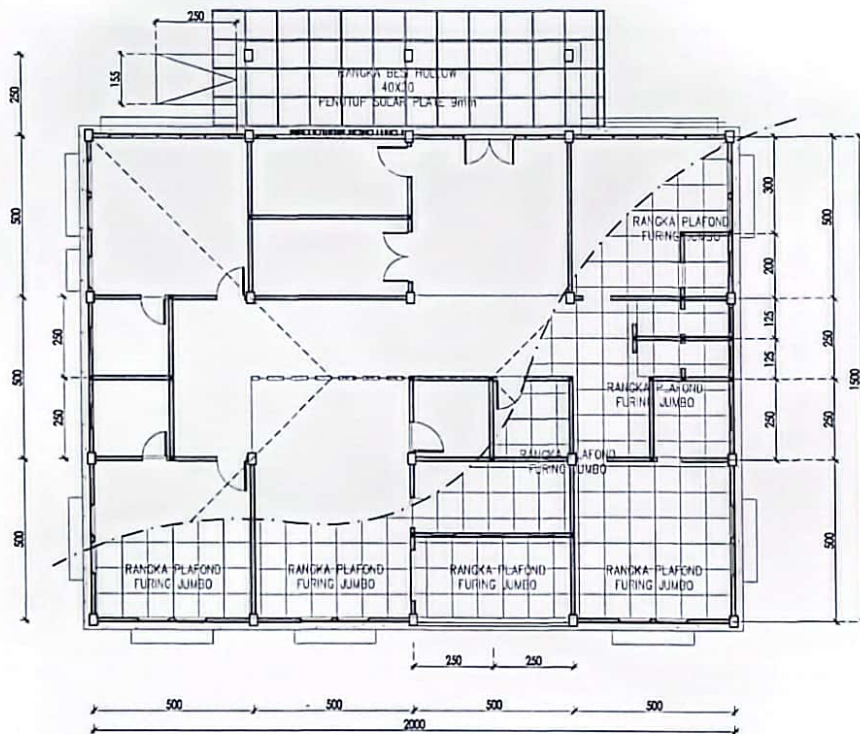

DENAH RENC. RANGKA PLAFOND
 SKALA 1 : 150

KETERANGAN		
NO	TANGGAL	KETERANGAN / REVISI
PEMBERI TUGAS		
 DINAS SOSIAL PROVINSI SUMATERA UTARA UPT PELAYANAN SOSIAL ANAK SIKKALANG KASANJAJHE		
MENYETUJUI KEPALA DINAS SOSIAL PROVINSI SUMATERA UTARA		
DR. PURSIANI PURNAMA WATI S. Si, Apr M. G. NIP. 19671227 195703 2 001		
 RAHMAT PRIBADI LUBIS ST		
KARYAKARYA EKSPLOITASI NIP. 19711229 200901 1 001 KONSULTAN PERENCANA		
 CV. PELITA BUANA PERENCANAAN		
TEAM LEADER		
 RAHMAT PRIBADI LUBIS ST		
KEGIATAN		
PERENCANAAN BANGUNAN PANTI ANAK SIKKALANG (UPT PELAYANAN SOSIAL ANAK SIKKALANG KASANJAJHE)		
TAHLUN ANGGARAN 2023		
JUDUL GAMBAR		
DENAH RENCANA RANGKA PLAFOND		
DI GAMBAR	ADI PRATAMA	
DIPERIKSA	SAIFUL M. HASAN	
PIKULIAWAN		
UNTUK		17
SKALA	1:150	
CAD FILE		

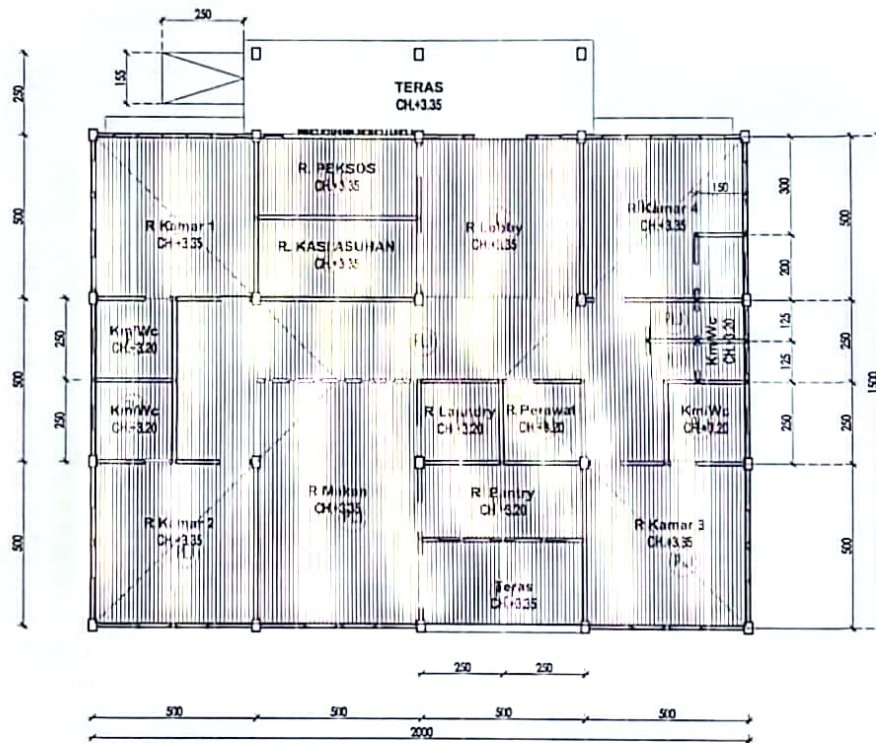

DENAH RENCANA PLAFOND
SKALA 1:150

KETERANGAN :
 (PLI) PLAFOND GYPSUM
 T=9MM

KETERANGAN		
NO	TANGGAL	KETERANGAN / REVISI
PEMBERI TUGAS		
 DINAS SOSIAL PROVINSI SUMATERA UTARA UPT PELAYANAN SOSIAL ANAK SINGKALANG KABUPATEN MENYETUJUI KEPALA DINAS SOSIAL PROVINSI SUMATERA UTARA		
DR. SURIANI PURNAMA WATI S. S. (Apt. M. Si) NIP. 19671207 199701 2 001		
MENGESTAFILI		
 MENGETAHUI PELAKSANA PELAYANAN KESEHATAN		
 KARELDEUS SINAGA SH NIP. 19711228 200901 1 001 KONSULTAN PERENCANA		
 TEAMI LEACER		
 MENGETAHUI BENDAHARA		
BENDAHARA BANGUNAN SIKHTI ANAK SINGKALANG (UPT PELAYANAN SOSIAL ANAK SINGKALANG KABUPATEN)		
TAMUN ANGGARAN 2023		
JUDUL GAMBAR		
DENAH RENCANA PLAFOND		
DI GAMBAR	ADI PRATAMA	R. ALYAN
DIREKSI	SARUL M NASRAN	
DISEKSI		
PERENCANA		
UNTUK		
SKALA	1:150	18
CAD FILE		

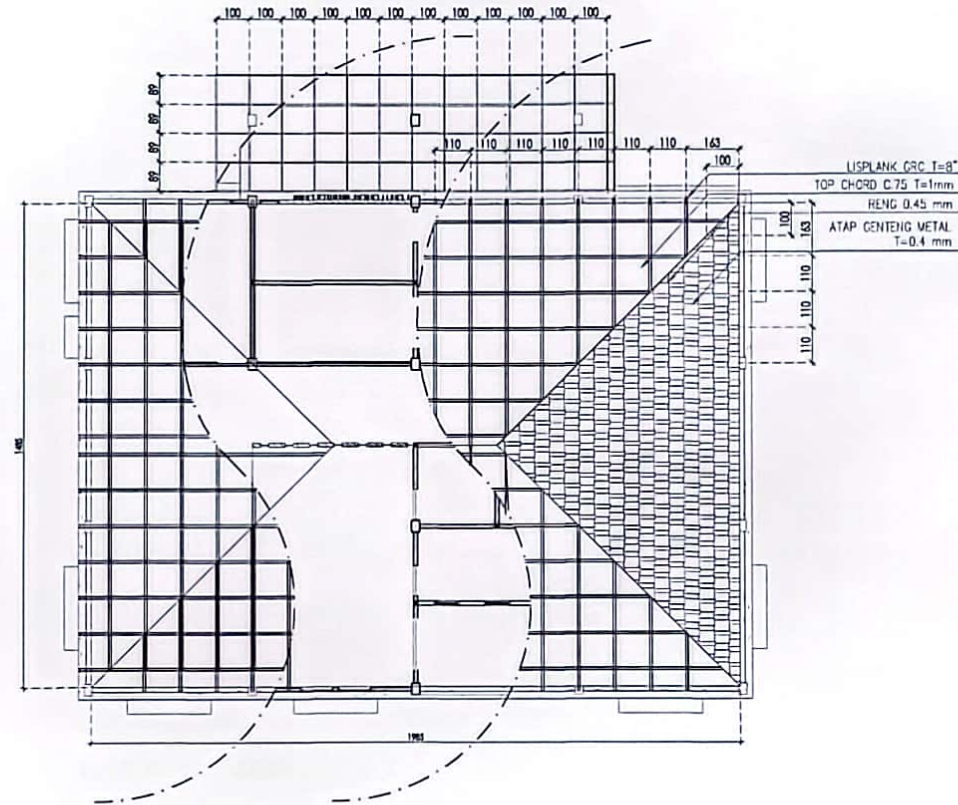

DENAH RENCANA RANGKA ATAP
 SKALA 1:150

KETERANGAN

NO	TANGGAL	KETERANGAN	PIRAM
REVISI			

PEMBERI TUGAS

**DINAS SOSIAL
 PROVINSI SUMATERA UTARA**
 UPT PELAYANAN SOSIAL ANAK
 SIKALANG-KABANJARI

MENYETUJUI
 KEPALA DINAS SOSIAL
 PROVINSI SUMATERA UTARA

DR. SURILANDI PUJINAMA, S.T., S.E., S.H., M.H.I.
 NIP. 19621222 199703 2 001



MENGETAPUJI
 PEJABAT PELAKSANA TEKNIK KEGIATAN



KARIM EL HASNY, S.T., S.H.
 NIP. 19711229 200801 1 001

KONSULTAN PERENCANA

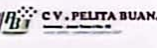
CV. PELITA BUANA

TEAM LEADER

 RAHMAT DR. HAZAL LUBIS, ST
 KEGIATAN

**PERENCANAAN BANGUNAN
 PANTI ANAK SIKALANG
 (UPT PELAYANAN SOSIAL ANAK
 SIKALANG-KABANJARI)**

TAHUN ANGGARAN 2023

JUDUL GAMBAR

**DENAH RENCANA
 RANGKA ATAP**

DI GAMBAR	ADI PRATAMA	19
DIREKSI	SAIFUL MAHALAN	
PERENCANAAN		
UNITS		
SKALA	1:150	
EAD FILE		

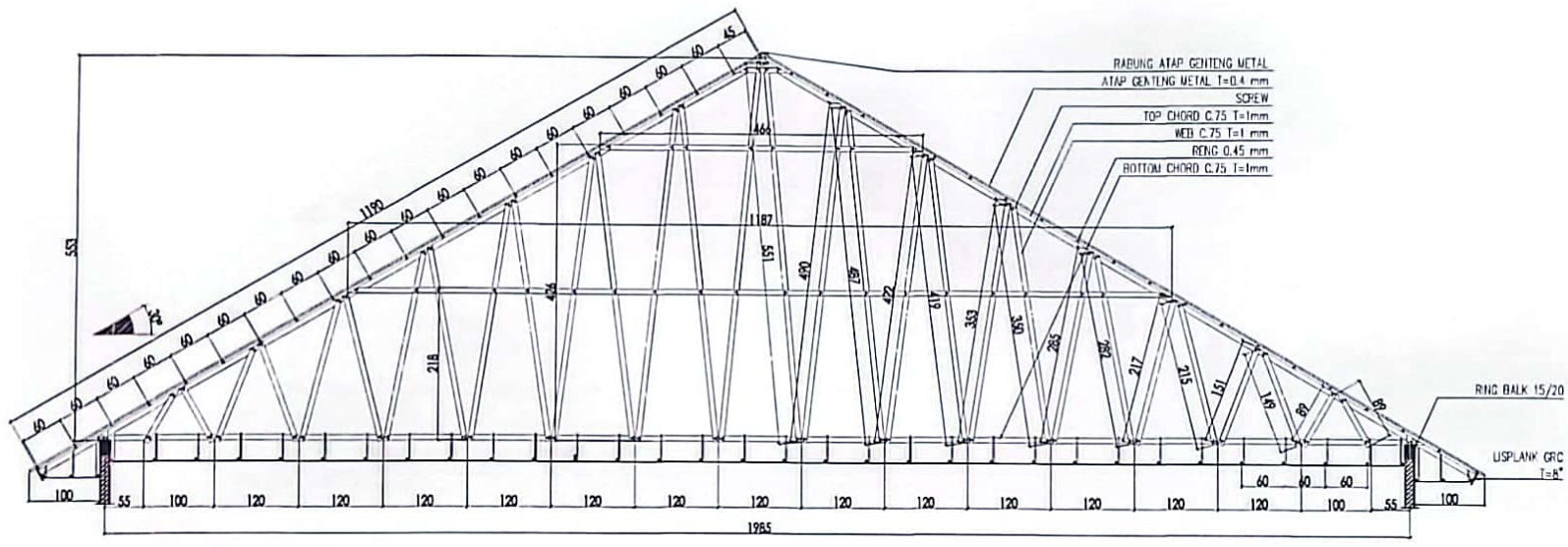

DETAIL POT. KUDA - KUDA (K1)
SKALA 1:70

KETERANGAN

NO	FANSAL	KETERANGAN	PARAF

REVISI

PEMBERI TUGAS

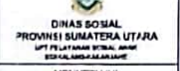

**DINAS SOSIAL
PROVINSI SUMATERA UTARA**
UPT PELAYANAN SOSIAL ANAK
SIDIKALANG KABANJAJE

MENYETUJUI
KEPALA DINAS SOSIAL
PROVINSI SUMATERA UTARA

DR. SURANI PURNAMA LATI S. SI. AM. M. SI.
NIP. 1.421227.197812.001

MENGETAHUI



MENGETAHUI
PELABAT PELAKSANA KEGIATAN

KARLIS M. M. S. S. S.
NIP. 1.911228.200811.001

KONSULTAN PERENCANA



TEAM LEADER

[Handwritten Signature]
PELABAT PELAKSANA KEGIATAN
YOGIATAM

TAHUN ANGGARAN 2023
JUDUL GAMBAR

**DETAIL POTONGAN
KUDA-KUDA**

DI GAMBAR	J. DI PRATAJA	2
DISETUJUI	5. MULI M. HASAN	20
SKALA	1:70	
CAD FILE		

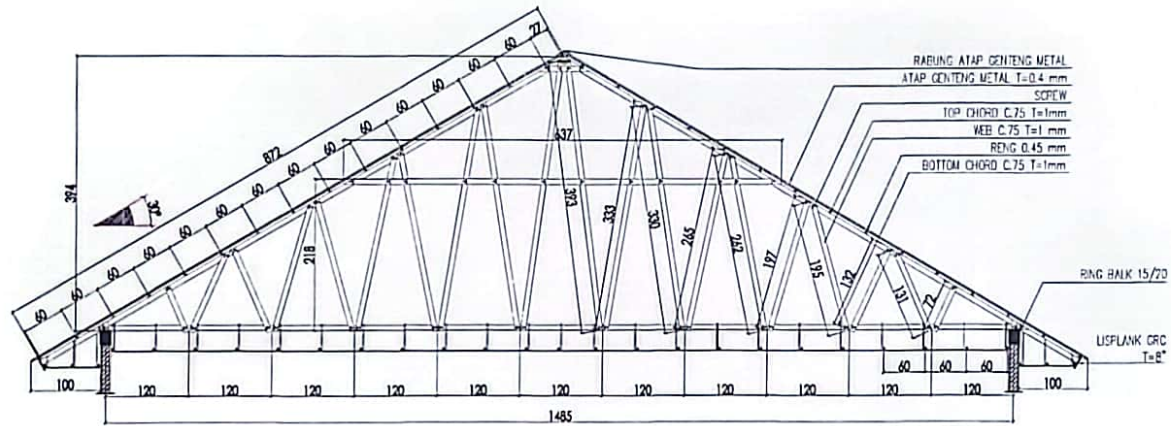

DETAIL POT. KUDA - KUDA (K2)
SKALA 1:70

KETERANGAN

NO	TAMBAHAN	KETERANGAN	PARAF
REVISI			
PEMBERI TUGAS			
 DINAS SOSIAL PROVINSI SUMATERA UTARA <small>UPT PELAYANAN SOSIAL ANAK SOKALANG KABANGJAMBE</small>			
MENYETUJUI			
KEPALA DINAS SOSIAL PROVINSI SUMATERA UTARA			
<small>DR. H. HILMAN RI. PALAMAYATI, S. E., M. M. S. NIP. 19611207 19073 2 001</small>			
MENYERAHKAN			
 KEPALA UPT PELANGGARAN DAN Kedisiplinan <small>UPT PELAYANAN SOSIAL ANAK SOKALANG KABANGJAMBE</small>			
MENYERAHKAN			
 KARLEWIS SINAGA, S.H. <small>NIP. 19771229 20091 1 001</small> KONSULTAN PERENCANAAN			
 CV. PELITA BUANA			
TEAM LEADER			
 PEPERANGKIN, R. <small>PEPERANGKIN, R.</small>			
 CV. PELITA BUANA <small>PEPERANGKIN, R.</small>			
KEGIATAN			
PERENCANAAN BANGUNAN PANTI ANAK SOKALANG (UPT PELAYANAN SOSIAL ANAK SOKALANG KABANGJAMBE)			
TAHUN ANGGARAN 2023			
JUDUL GAMBAR			
DETAIL POTONGAN KUDA-KUDA			
DI GAMBAR	ADI PRATAMA		
DIPERIKSA	SAIFUL M. HALAN		
DITETAPKAN			
PELAKSANAAN			
UNTUK			
SKALA	1:70		21
CAD FILE			

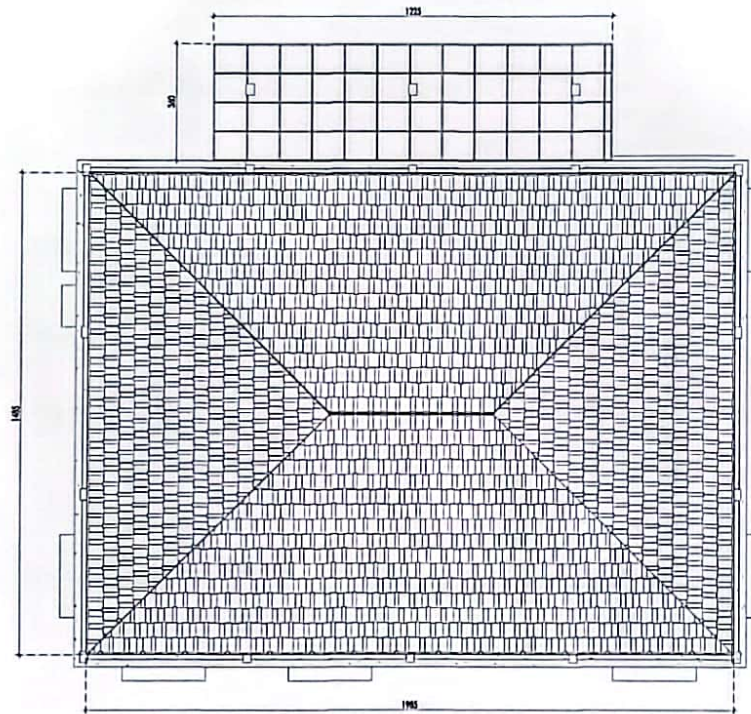

DENAH ATAP
SKALA 1:150

KETERANGAN

NO	TANGGAL	KETERANGAN	REVISI

PEMBERI TUGAS



**DINAS SOSIAL
PROVINSI SUMATERA UTARA
DINAS SOSIAL ANAK SISKALANG
KABUPATEN SIJUNJUNG**

MENYETUJUI

**KEPALA DINAS SOSIAL
PROVINSI SUMATERA UTARA**

SRI SULISANI PRINHALALATI S. SI Apt M. Si
NIP. 1982.12.01.200811.001



PEMERAT PEKERJA/KELOMPOK KEGIATAN

[Handwritten Signature]

KARLINA WILDE DINHACA TH
NIP. 1971.02.20.200911.001

KONSULTAN PERENCANA

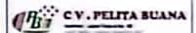

TEAM LEADER



KEGIATAN

**PERENCANAAN BANGUNAN
PANTI ANAK SISKALANG
(SUPT PELAYANAN SOSIAL ANAK
SISKALANG KABUPATEN SIJUNJUNG)**

TAHUN ANGGARAN 2023

JUDUL GAMBAR

DENAH ATAP

DI GAMBAR: ADI PRATAMA

DIREKTOR: SAHILU M. HASAN

PELAKSIAN: []

SKALA: 1:150

CAD FILE

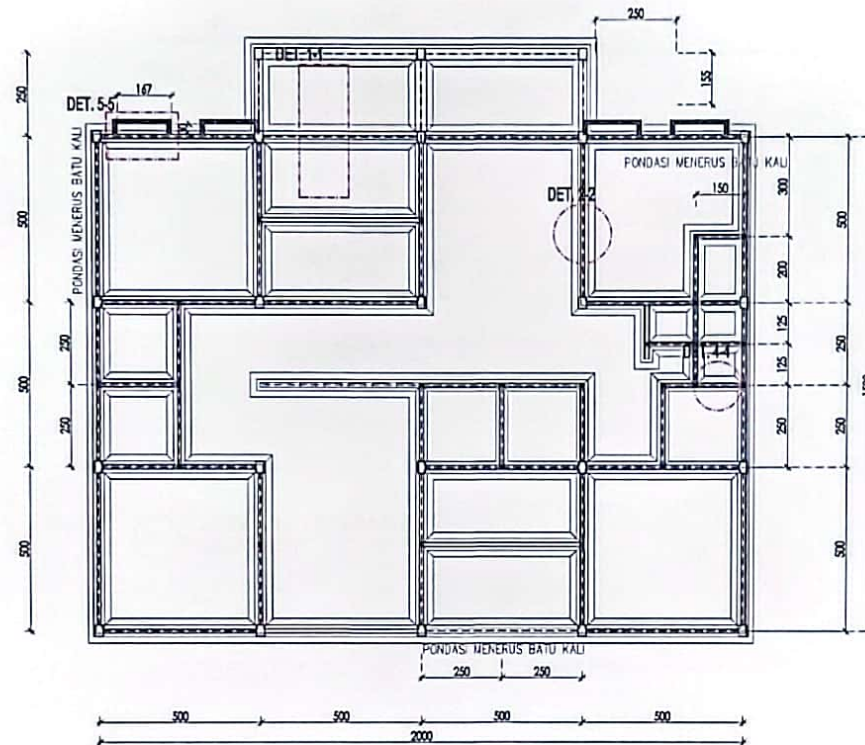

DENAH RENCANA PONDASI
 SKALA 1:150

KETERANGAN

NO	TAMBAHAN	KETERANGAN	PARAF

REVISI

PEMBERI TUGAS



**DINAS SOSIAL
 PROVINSI SUMATERA UTARA**

UNIT PELAYANAN SOSIAL (UPSS)
 SIKOLANG KASANJAH

MENYETUJUI

KETALA DINAS SOSIAL
 PROVINSI SUMATERA UTARA

DR. H. PELITA BUANA, S.T., S.Si, M. Si
 NIP. 19621221 1982 3 001



MENGETAHUI

PELEBAT PELAKSANA TEKNIS KEGIATAN

[Signature]

KAR. EDICANDUS SINAGA, S.H.
 NIP. 19711228 200807 1 001

KONSULTAN PERENCANA



TEAM LEADER



PERENCANAAN BANGUNAN
 PANTI ANAK SIKOLANG
 (UNIT PELAYANAN SOSIAL ANAK
 SIKOLANG KASANJAH)

TAHLIN ANGGARAN 2023

JUDUL GAMBAR

DENAH RENCANA PONDASI

DI GAMBAR	ADZ PRATAMA	NOORAH
DIREKTOR	SAFUA MAHASAN	23
PELEBATAN		
UNIT		
SKALA	1:150	

LAD FILE

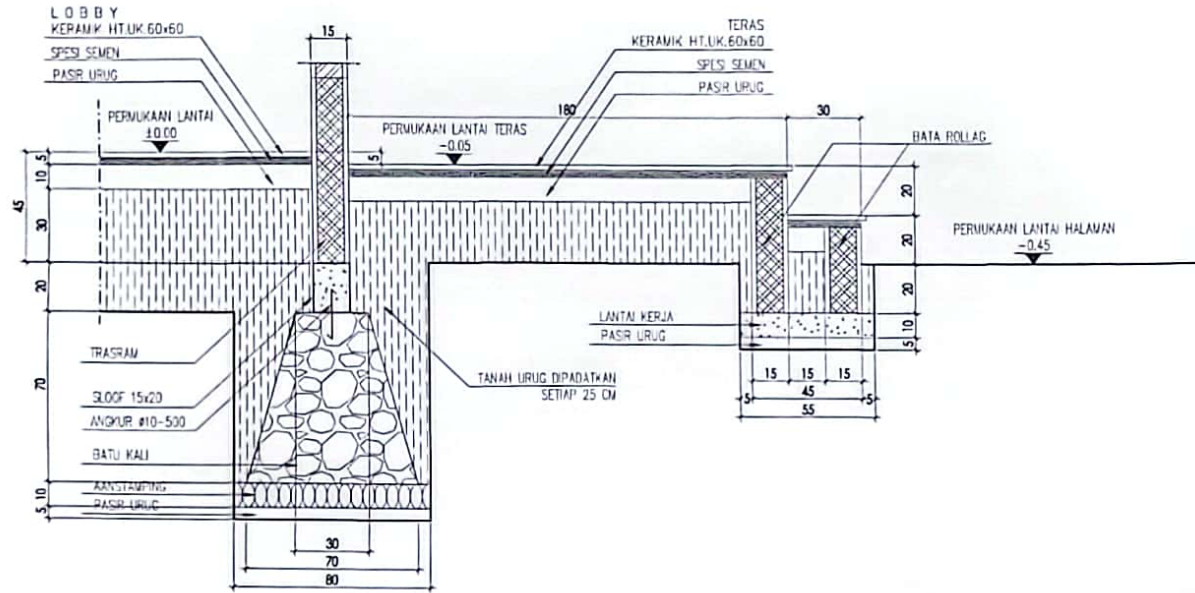

DETAIL 1 - 1 PONDASI MENERUS
SKALA 1:20

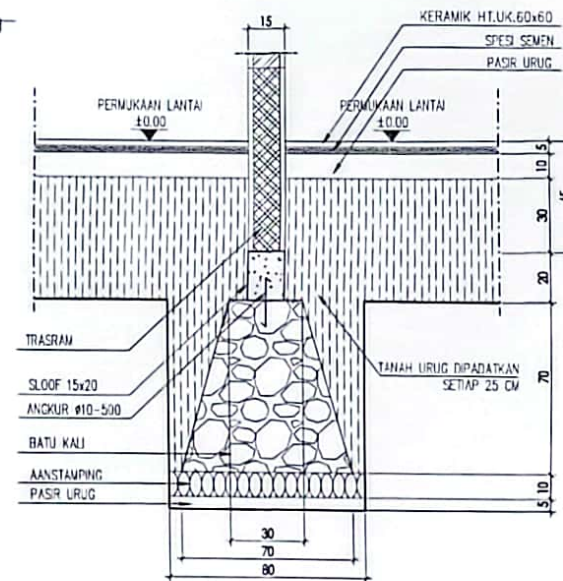

DETAIL 2 - 2 PONDASI MENERUS
SKALA 1:20

KETERANGAN

NO	TANGGAL	PETREKSIAN	REVISI	PIRUPAK

PEMERIKSA TUJAS

DINAS SOSIAL
PROVINSI SUMATERA UTARA
UPT PELAYANAN SOSIAL ANAK
SIBOLGA KABUPATEN SIBOLGA

MENYETUJUKAN

KEPALA DINAS SOSIAL
PROVINSI SUMATERA UTARA

DR. SUHANI PURNAMA WATI S. ST. A. M. S.
NIP. 198112271997032001

MENGETAHUI

KEPALA UPT PELAYANAN SOSIAL ANAK
SIBOLGA KABUPATEN SIBOLGA

MENGETAHUI

PERAKTOR PUSKALINTELEKAGANGAN
KARLENDONUS SIBOLGA SIA
NIP. 198112282008031001

KONSULTAN PERENCANA

CV. PELITA BUANA
Jalan ...

TEAM LEADER

PAIMAN PRIBADI LUBIS SIA
NIP. ...

KEGIATAN

PERENCANAAN BANGUNAN
PANTI ANAK SIBOLANG
(UPT PELAYANAN SOSIAL ANAK
SIBOLANG KABUPATEN SIBOLGA)

TAHUN PENGANTARAN 2023

JUDUL GAMBAR

DETAIL PONDASI MENERUS

DI GAMBAR	ADI PRATAMA	1	1
DIPERIKSA	SAPUL M. HASAN	1	1
DIVALIDASI			
UNTUK			
SKALA	1:20		

EAD FILE

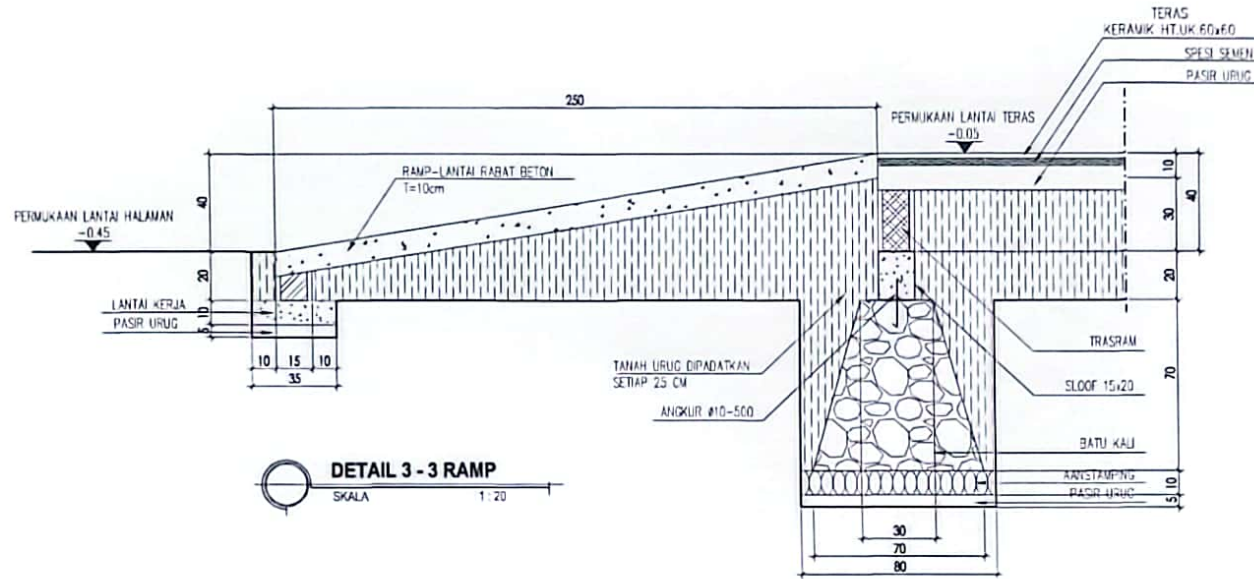

DETAIL 3-3 RAMP
SKALA 1:20

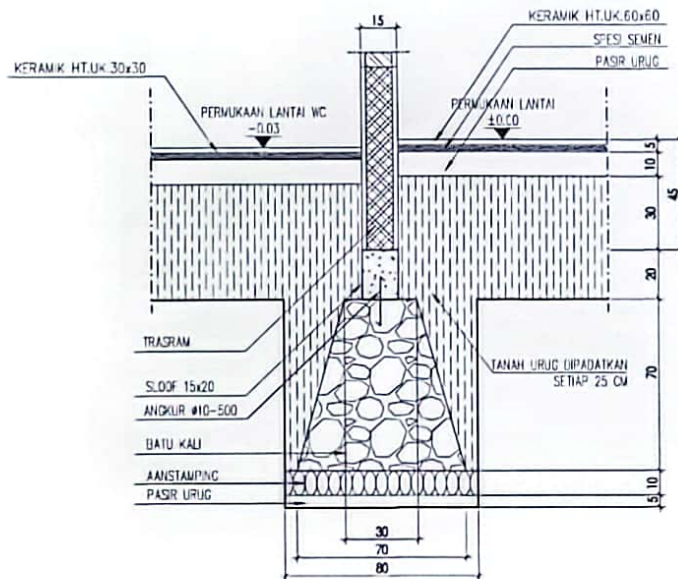

DETAIL 4-4 PONDASI MENERUS
SKALA 1:20

KETERANGAN

NO	FUNGSI	KETERANGAN	REVISI
PEMBERI TUGAS			
 DINAS SOSIAL PROVINSI SUMATERA UTARA UPT PELAYANAN SOSIAL ANAK SIDIKALANG KASABANJAH			
MENYETUJAI			
KEPALA DINAS SOSIAL PROVINSI SUMATERA UTARA			
DITURUNKAN PERMANEN/ALTERNATIF/DI RUMAH MASYARAKAT			
NIP. 14673071400011001			
MENGUJUTAMA			
KEPALA UPT PELAYANAN SOSIAL ANAK SIDIKALANG KASABANJAH			
 KARLI ENDANG SINAGA, SH NIP. 141171201100011001 KONSULTAN PERENCANAAN			
 CV. PELITA BUANA PERENCANAAN BANGUNAN PANTI ANAK SIDIKALANG (UPT PELAYANAN SOSIAL ANAK SIDIKALANG KASABANJAH) TAHUN ANGGARAN 2023 JUDUL GAMBAR DETAIL PONDASI MENERUS & RAMP			
TEAM LEADER			
 RANI PERENCANAAN BANGUNAN PANTI ANAK SIDIKALANG (UPT PELAYANAN SOSIAL ANAK SIDIKALANG KASABANJAH) TAHUN ANGGARAN 2023 JUDUL GAMBAR DETAIL PONDASI MENERUS & RAMP			
KEGIATAN			
PERENCANAAN BANGUNAN PANTI ANAK SIDIKALANG (UPT PELAYANAN SOSIAL ANAK SIDIKALANG KASABANJAH) TAHUN ANGGARAN 2023 JUDUL GAMBAR DETAIL PONDASI MENERUS & RAMP			
JUDUL GAMBAR			
DETAIL PONDASI MENERUS & RAMP			
DI GAMBAR	ACU PRATAMA		
DIPERIKSA	SAPUL M. HASAN		
DITETAPKAN			
SKALA	1:20		
CAD FILE			

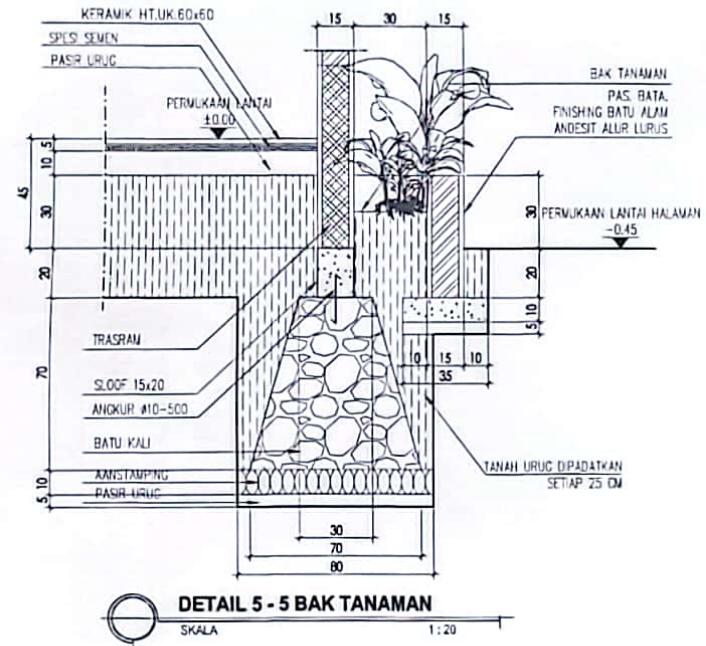
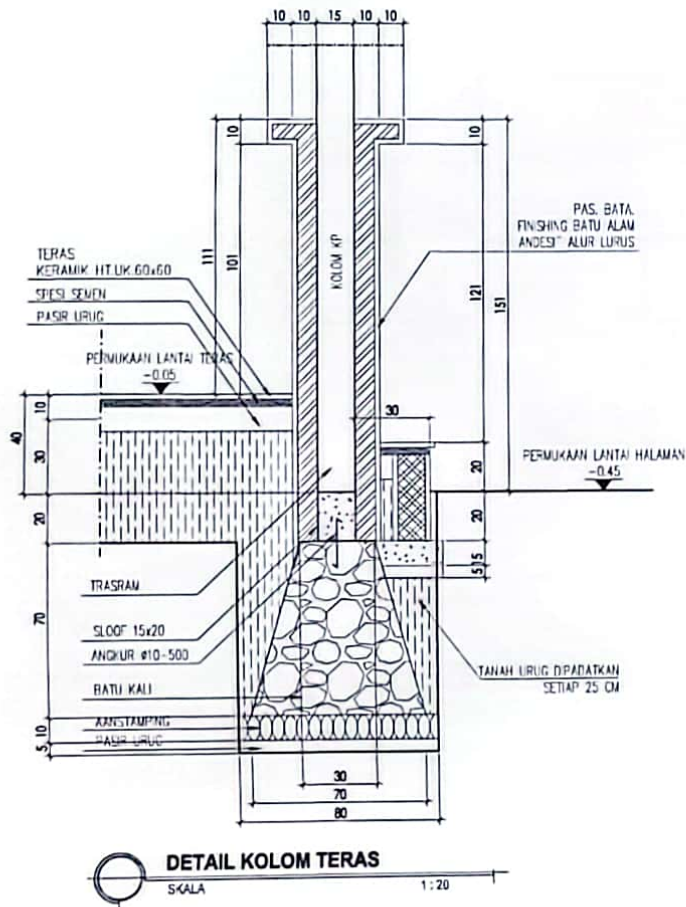

KETERANGAN

NO	TAMBAH	KETERANGAN	REVISI

REVISI

PEMERIKHA TUJAS



DINAS SOSIAL
PROVINSI SUMATERA UTARA

UPT PELAYANAN SOSIAL ANAK
SIDIKALANG-KABANGJAH

MENYETUJUI

KEPALA DINAS SOSIAL
PROVINSI SUMATERA UTARA

PERATURAN PERUMAHAN PT. S. S. APT. M. S.
NO. 12/2007/PT. S. S. APT. M. S.



PEJABAT PELAYANAN NEGARA

[Signature]

KARLETONA SIBOLGA SH

NO. 12/2007/PT. S. S. APT. M. S.

KONSULTAN PERENCANA



TEAM LEADER



FAHMAD IBRAHIM LUBIS ST

KEGIATAN

PERENCANAAN BANGUNAN
PANTI ANAK SIDIKALANG
(UPT PELAYANAN SOSIAL ANAK
SIDIKALANG-KABANGJAH)

TAHUN ANGGARAN 2023

AUDIAL GAMEAR

DETAIL KOLOM TERAS
DETAIL BAK TANAMAN

DI GAMBAR	ADI PRATAMA	
DIREKTUR	SAFUD M. HALIM	
PEREDARAN		
UNTUK		
SKALA	1:20	
END FILE		

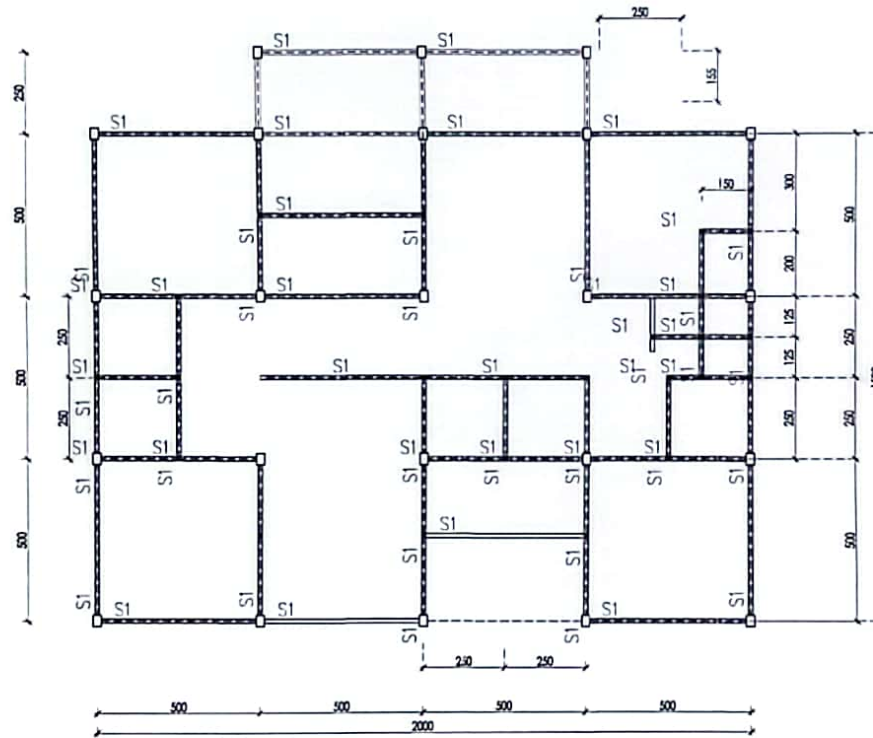

DENAH RENCANA SLOOF
SKALA 1:150

KETERANGAN

NO	FUNGSI	KETERANGAN	FORM
REVISI			

PEMBERI TUGAS

**DINAS SOSIAL
 PROVINSI SUMATERA UTARA**
 KEPALA DINAS SOSIAL
 PROVINSI SUMATERA UTARA

MENYETUJUI
 KEPALA DINAS SOSIAL
 PROVINSI SUMATERA UTARA

DR. ELPRAN PURNAMA WATI S. S. Apt. M.S.
 NIP. 196707111990121001

MENGETAHUI

 KEPALA DINAS SOSIAL
 PROVINSI SUMATERA UTARA

 KAREL P. M. S. SINAGA S.T.
 NIP. 197102011990121001

KONSULTAN PERENCANA

CV. PELITA BUANA

TEAM LEADER



 HAMZA D. S. L. S. T.
 KEGIATAN

**PERENCANAAN BANGUNAN
 PANTI ANAK SIKHALANG
 (UPT PELAYANAN SOSIAL ANAK
 SIKHALANG KASANJIH)**

TAHUN ANGGARAN 2023

JUDUL GAMBAR

DENAH RENCANA SLOOF

DI GAMBAR	ADI PRATAMA		
DIREKTUR	SAIFUL M. HUSAIN		
PERENCANA			
UNTUN			
SALA	1130		
EA0 FILE			

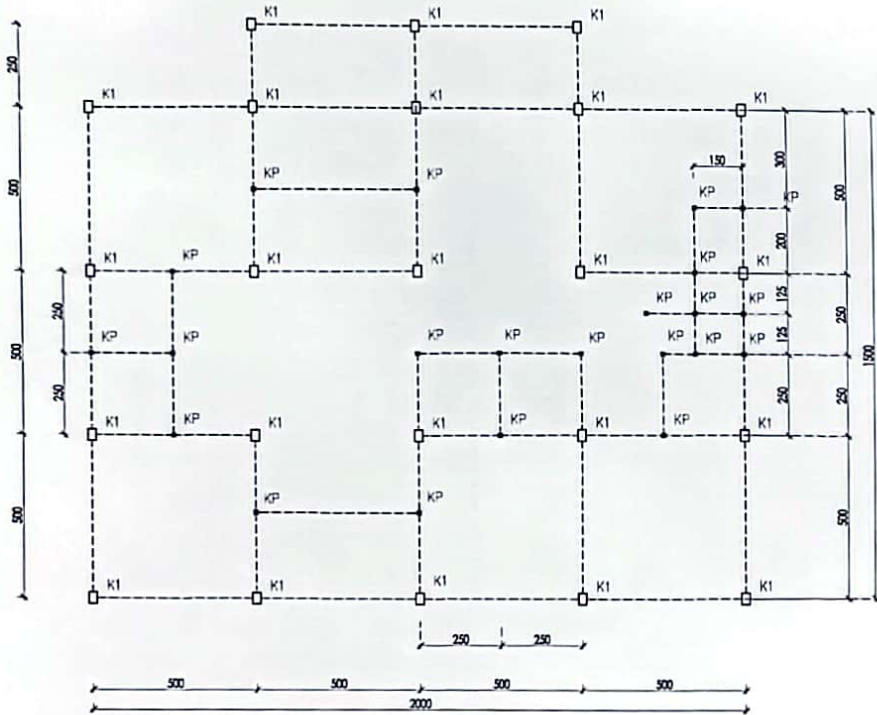

DENAH RENCANA KOLOM BAWAH
SKALA 1:150

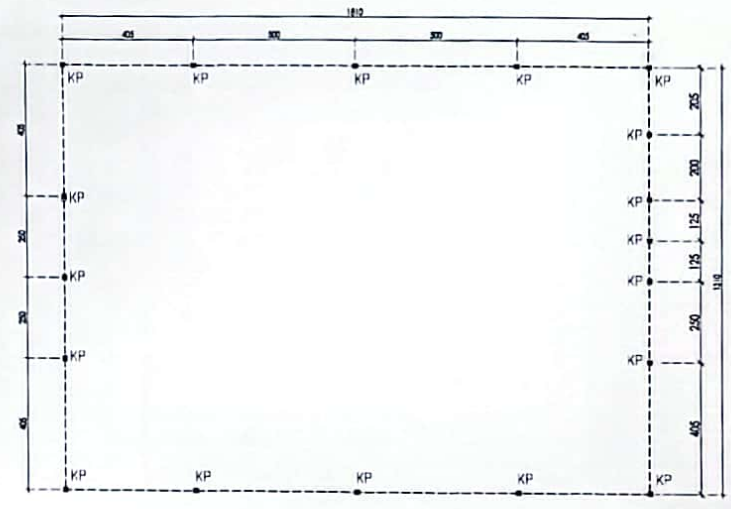

DENAH RENCANA KOLOM ATAS
SKALA 1:150

KETERANGAN

NO	TANGGAL	KETERANGAN	PIRAN
REVISI			

PEMERIKSA TUJAS

DINAS SOSIAL
PROVINSI SUMATERA UTARA
 JALAN PANGLOSSI NO. 100
 MEDAN 50132
MENYETUJUI
 KEPALA DINAS SOSIAL
 PROVINSI SUMATERA UTARA

DR. SULISANI PURNAMA RATI S. S. S. S. S.
 NIP. 19611221197712203

MENGETAHUI

MENGETAHUI
 PELAKSANAAN PROJEK USAHA KEAGAMAAN

KAPRIBUNDA SITI SIHAGA, S.H.
 NIP. 196712281980111001
 KONSULTAN PERENCANAAN

TEAM LEADER



 ROFIQ
 HANMAD HUSACK, I.B.S. ST.
 KEGIATAN

YUSREKHAAN BANGUNAN
 PANTI ANAK SIKALANG
 (UPT PELAYANAN SOSIAL ANAK
 SIKALANG KABUPATEN)

TAHUN ANGGARAN 2023
 JUDI B. GAMBAR

DENAH RENCANA KOLOM

DI GAMBAR	AD PRATAMA	1
DIREKTOR	SATFUS M. HASAN	2
KEPALA DINAS	UNYUS	3
SKALA	1:150	
CAD FILE		

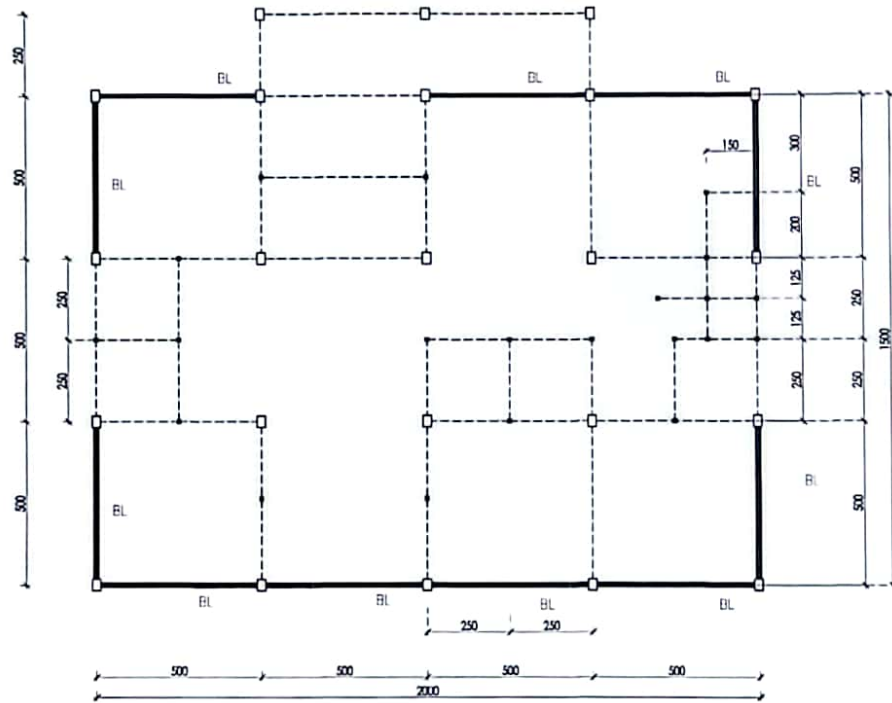

DENAH RENCANA BALOK LANTAI ELV. +2.29
 SKALA 1:150

KETERANGAN

NO	TANGGAL	KETERANGAN	PIRAWI
REVISI			

PEMBERI TUGAS



DR. H. IRWAN PURNAMA (NIP. 1963031201201001)

MENGETAHUI



MENGETAHUI

KAPRIBUMIHAN SIKALANGKABANG
 NIP. 197103120081201001

KONSULTAN PERENCANA



TEAM LEADER

MENGETAHUI

KEMALIHATI (NIP. 197103120081201001)
 KEGIATAN

REBENCANAN BANGUNAN RANTI ANAK SIKALANG (UPT PELAYANAN SOSIAL ANAK SIKALANG-KABANJAH)

TAHLUN ANGGARAN 2023

JUDUL GAMBAR

DENAH RENCANA BALOK LANTAI

DI GAMBAR	ADD PRATIKA	
DIREKSI	SIMPUL M. HILMAN	
DISTRIBUSI		3
PERLUKUTAN		
UNITAS		
SKALA	1:150	
CAD FILE		

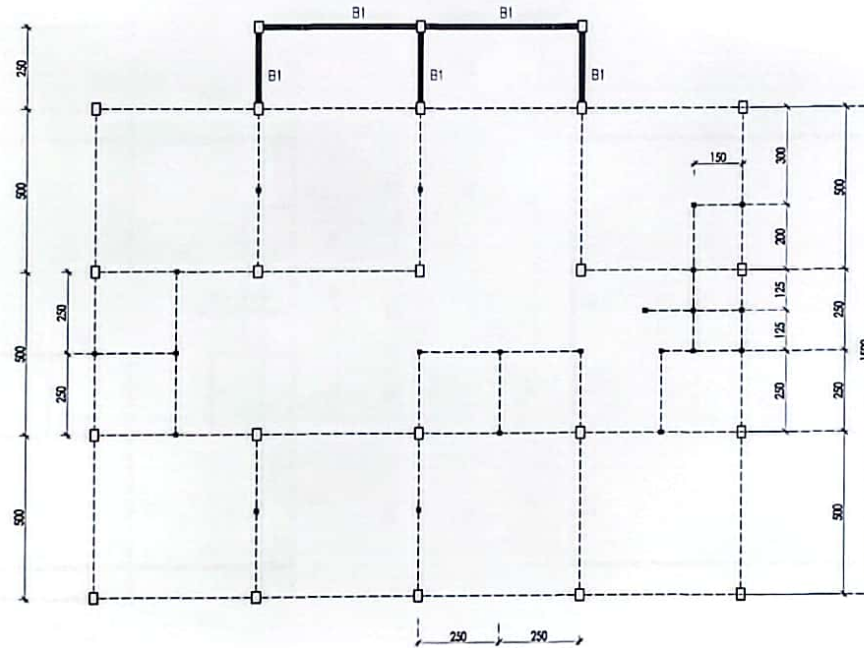

DENAH RENCANA BALOK TERAS ELV. +3.35
SKALA 1:150

KETERANGAN		
NO	TANGGAL	REVISI
PEMBERI TUGAS		
 DINAS SOSIAL PROVINSI SUMATERA UTARA <small>UPT PELAYANAN SOSIAL ANAK SIKKALANG KABANJAHU</small>		
MENYETUJUI		
<small>KEPALA DINAS SOSIAL</small> <small>PROVINSI SUMATERA UTARA</small>		
<small>DR. TURRIANI PURNAMA WATI S. ST. Agt. M. Si</small> <small>NIP. 198112071987192 001</small>		
MENGETAHUI		
<small>KEPALA DINAS SOSIAL</small>  <small>DINAS SOSIAL</small> <small>PROVINSI SUMATERA UTARA</small>		
MENGETAHUI		
<small>PENYALUT PELAYANAN TERUS BERKUALITAS</small>  <small>KARLITO JULIUS</small> <small>NIP. 19711228200211 001</small> <small>KONSULTAN PERENCANAAN</small>		
 C.V. PELITA BUANA <small>Konsultan Perencanaan</small>		
TEAM LEADER		
 <small>FAHMAD</small> <small>STRUKTURIS ST</small>		
KEGIATAN		
<small>PERENCANAAN BANGUNAN</small> <small>PANTI ANAK SIKKALANG</small> <small>(UPT PELAYANAN SOSIAL ANAK SIKKALANG KABANJAHU)</small>		
TAHUN ANGGARAN 2023		
JUDUL GAMBAR		
DENAH RENCANA BALOK TERAS		
DI GAMBAR	ADH PRATAMA	1:150
DIPERIKSA	SAIFUL M. HASAN	30
DIREVISI		
DITANDA TANGAN		
SKALA	1:150	
CAD FILE		

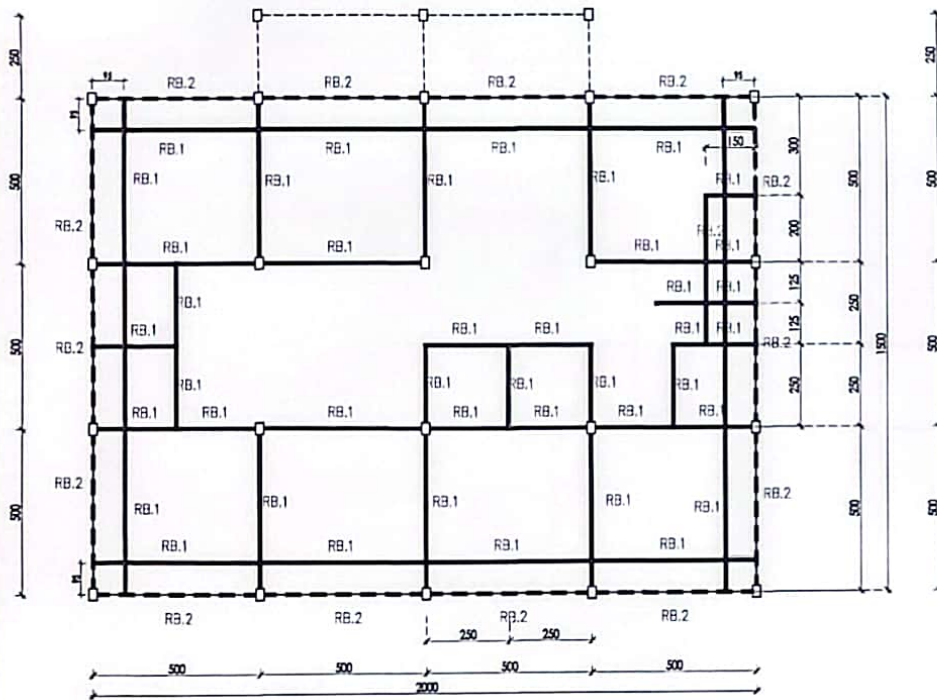

DENAH RENCANA RING BALOK ELV. +3.50
SKALA 1:150

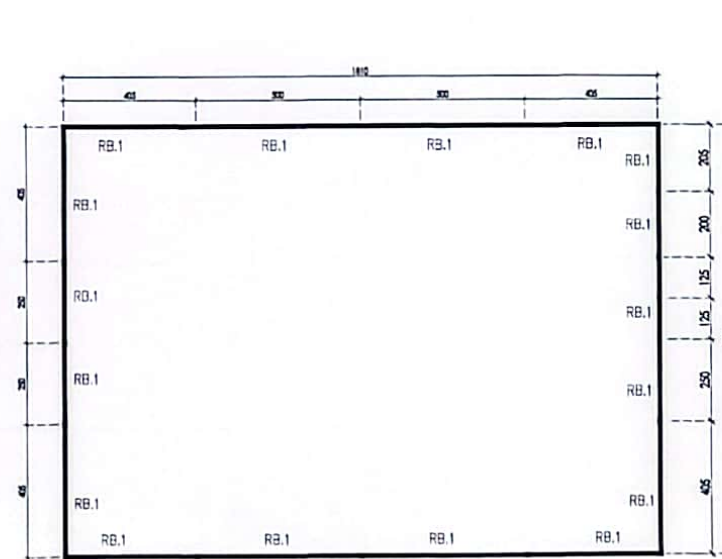

DENAH RENCANA RING BALOK ELV. +4.25
SKALA 1:150

KETERANGAN

NO	TANGGAL	KETERANGAN	PARAF

PEMBERI TUGAS

DINAS SOSIAL
PROVINSI SUMATERA UTARA
 UPT PELAYANAN SOSIAL ANAK
 SIKERLANG-KABANJAH
 MENYETUJUI
 KEPALA DINAS SOSIAL
 PROVINSI SUMATERA UTARA

DR SURBANI PURNAMAWATI S. SI, Apt, M.Si
 NIP. 19671227 19793 2 001

 KEPALA DINAS SOSIAL
 PROVINSI SUMATERA UTARA
 MENGETAHUI
 PEKERJAAN
 KONSULTAN PERENCANAAN

 KARELTONIUS SINAGA, Ph.D.
 NIP. 19471228 19731 1 001
 KONSULTAN PERENCANAAN

C.V. PELITA BUANA

TEAM LEADER



 RAUNILY PRATIWI LUBIS, S.T.
 KEGIATAN

PERENCANAAN BANGUNAN
 PANTI ANAK SIKERLANG
 (UPT PELAYANAN SOSIAL ANAK
 SIKERLANG-KABANJAH)

TAHUN ANGGARAN 2023

JUDUL GAMBAR

**DENAH RENCANA
 RING BALOK**

DI GAMBAR	ADI PRATAMA	
DIREKSI/PEKERJAAN	SARUL M HASAN	
DISTRIK/PEKERJAAN		
JMLH		31
SKALA	1:150	
CAD FILE		

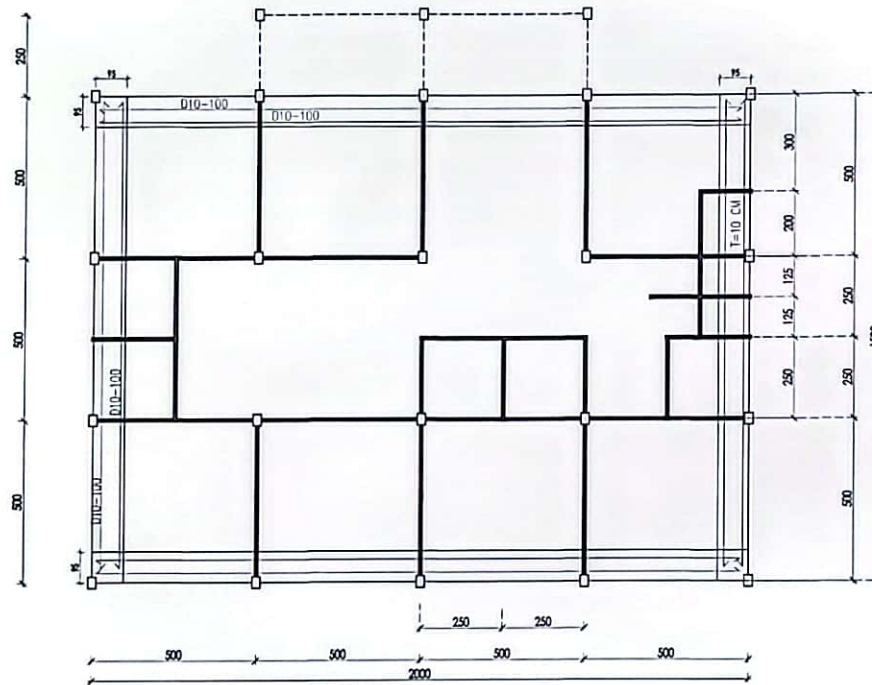

DENAH RENCANA TULANGAN DAK ELV. +3.50
 SKALA 1:150

KETERANGAN

NO	TANGGAL	KETERANGAN	PIRIPAP
REVISI			

PEMBERI TUGAS

DINAS SOSIAL
PROVINSI SUMATERA UTARA
 UPT PELAYANAN SOSIAL ANAK
 SIKALANG-KABUPATEN JAJAH

MENYETUJUI

KEPALA DINAS SOSIAL
PROVINSI SUMATERA UTARA

SRI SULIHANI PURNAMA WATI S S2 Agt M Si
 NIP. 196712071907192001

MENGETAHUI

KEPALA DINAS SOSIAL
PROVINSI SUMATERA UTARA
 UPT PELAYANAN SOSIAL ANAK
 SIKALANG-KABUPATEN JAJAH

MENGETAHUI

PELAKSANA PELAKSANA TEKIS KEGIATAN

FAMHAD
 NIP. 19711229200311001

KONSULTAN PERENCANA

CV. PELITA BUANA

TEAM LEADER



FAMHAD
 NIP. 19711229200311001

KEGIATAN

PERENCANAAN BANGUNAN
PANTI ANAK SIKALANG
(UPT PELAYANAN SOSIAL ANAK
SIKALANG-KABUPATEN JAJAH)

TAHUN ANGGARAN 2023

JUDUL GAMBAR

DENAH RENCANA
TULANGAN DAK

DI GAMBAR	ADI PRATAMA	1
SUPERVISOR	SARILU M HASAN	32
PEKERJA KARYA		
UNTUK		
SKALA	1:100	
EAD FILE		

STRUKTUR BALOK	SLOOF-S1 (150x200)			RNC BALOK-RB.1 (150x200)			RNC BALOK-RB.2 (200x300)		
	TUMPUAN 1/4	LAPANGAN 1/2	TUMPUAN 1/4	TUMPUAN 1/4	LAPANGAN 1/2	TUMPUAN 1/4	TUMPUAN 1/4	LAPANGAN 1/2	TUMPUAN 1/4
TULANGAN ATAS	2 D13	2 D13	2 D13	2 D13	2 D13	2 D13	3 D13	3 D13	3 D13
TULANGAN TENGAH	-	-	-	-	-	-	-	-	-
TULANGAN BAWAH	2 D13	2 D13	2 D13	2 D13	2 D13	2 D13	3 D13	3 D13	3 D13
SENGKANG	D6-100	D6-150	D6-100	D6-100	D6-150	D6-100	D6-100	D6-150	D6-100
STRUKTUR BALOK	BALOK LATEI-BL (110x150)			BALOK TERAS-BI (150x200)+PL500x100					
	TUMPUAN 1/4	LAPANGAN 1/2	TUMPUAN 1/4	TUMPUAN 1/4	LAPANGAN 1/2				
TULANGAN ATAS	2 D10	2 D10	2 D10	6 D13	6 D13				
TULANGAN TENGAH	-	-	-	-	-				
TULANGAN BAWAH	2 D10	2 D10	2 D10	2 D13	2 D13				
SENGKANG	D6-150	D6-150	D6-150	D6-100	D6-150				
STRUKTUR KOLOM	KOLOM K1 (200x250)	STRUKTUR KOLOM	KOLOM KP (150x150)						
TULANGAN UTAMA	6 D13	TULANGAN UTAMA	4 D13						
SENGKANG	D6-150	SENGKANG	D6-150						

TABEL PEMBESIAN
SKALA 1 : 20

KETERANGAN

NO. TANGGAL REVISI PERUBAHAN

REVISI

PEMBERI TUGAS



DINAS SOSIAL
PROVINSI SUMATERA UTARA
UPT PELAYANAN SOSIAL ANAK
SIDIKALANG

MENYETUJUI

KETUA DINAS SOSIAL
PROVINSI SUMATERA UTARA

DR. SURBANI PURNAMA (WATI) S. S. A. M. S.
NIP. 19671217 197023 2 001

MENGETAHUI

KAPALAKSANA DINAS SOSIAL ANAK
PROVINSI SUMATERA UTARA



MENGETAHUI

KAPALAKSANA DINAS SOSIAL ANAK
PROVINSI SUMATERA UTARA
NIP. 19711228 200101 1 001

KONSULTAN PERENCANA

C.V. PELITA BUANA

TEAM LEADER

KEGIATAN

PERENCANAAN BANGUNAN
PANTI ANAK SIDIKALANG
(UPT PELAYANAN SOSIAL ANAK
SIDIKALANG KASABAN/AHE)

TAHUN ANGGARAN 2023

JUDUL GAMBAR

TABEL PEMBESIAN

DI GAMBAR ADI PRATAMA

DIPERIKSA SAIFUL M. HASAN

PERENCANAAN
UNIT-1

SKALA 1:20

CAD FILE

NO. 33

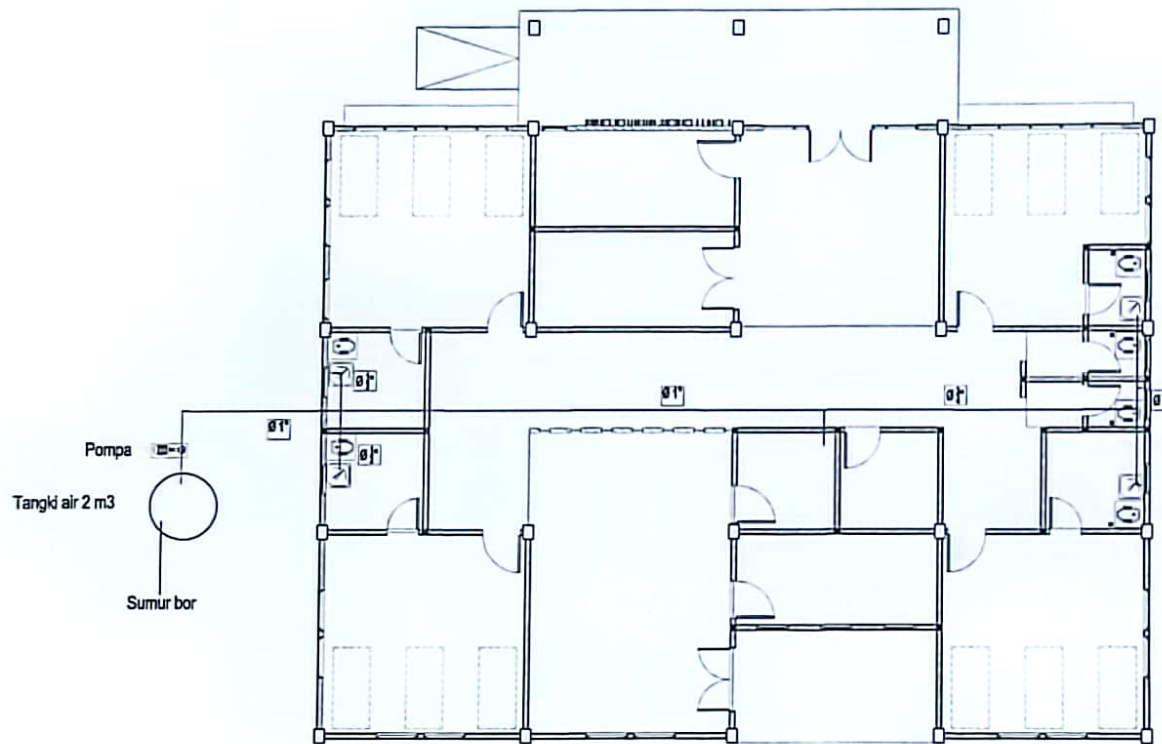

Pompa
Tangki air 2 m³
Sumur bor

RENCANA INSTALASI AIR BERSIH
SKALA NTS

KETERANGAN		
NO	TANDA	REVISI
PEMERIKSA TUGAS		
 DINAS SOSIAL PROVINSI SUMATERA UTARA <small>JPT. P. 1000/2016</small> MEMUTUSKAN MENYETUJUI PERALTAH DAN ALAT BAHAN KELOMPOK KERJA KELOMPOK KERJA KELOMPOK KERJA		
 SEKRETARIS PRALAK PUSKESMAS TIKUS KEDIRIAN		
 * MENDIRI KEMENTERIAN RI * MENDIRI KEMENTERIAN RI * MENDIRI KEMENTERIAN RI		
 CV. PELITA SUKSES TEAM LEADER		
 * MENDIRI KEMENTERIAN RI * MENDIRI KEMENTERIAN RI * MENDIRI KEMENTERIAN RI		
RENCANA INSTALASI AIR BERSIH PARTI ANAS SUDH ALANG SPT PELAYANAN SOSIAL ANAS SEKALANG BANGUNAN		
TANGKUPAN KEMENTERIAN RI JUDUL GAMBAR RENCANA INSTALASI AIR BERSIH		
NO. GAMBAR: ... SKALA:		

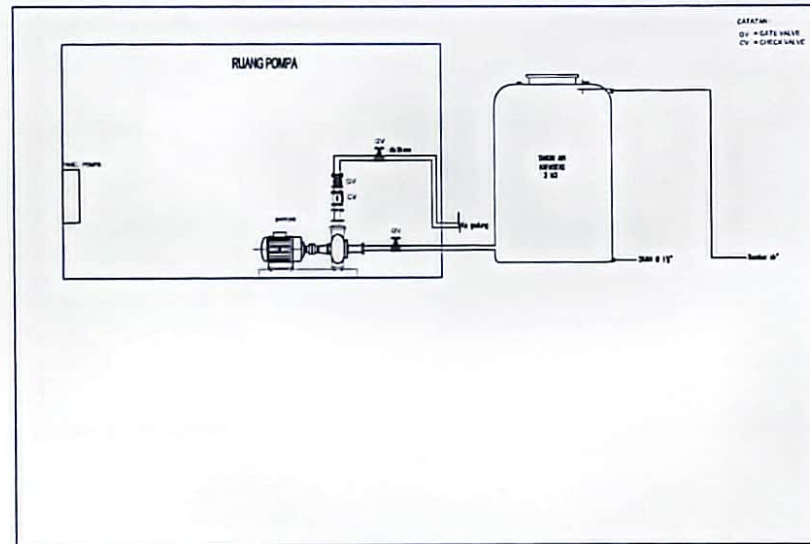
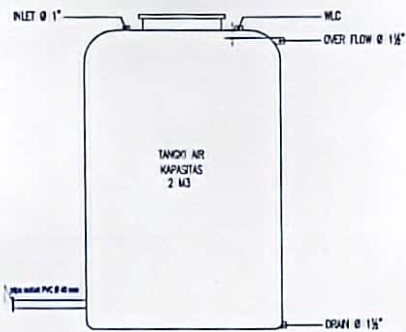

DETAIL POMPA & TANGKI AIR
 SKALA NTS

KETERANGAN

NO	TANGGAL	REVISI/REVISI	SIKAP

PEMBERI TUGAS



MENYETUJUI
KEPALA DINAS SOSIAL
PROVINSI SUMATERA UTARA

SRI SURIANI PURNAMA WATI, S. Si, Apt. M. Si.
0812 7081 7081



PEJABAT PELAKSANA TIANG KEGIATAN

(Signature)

KARL EDY HENDRI SINGALANG, S. Si
0812 7081 7081

KONSULTAN PERENCANA

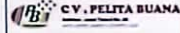

TEAM LEADER

(Signature)
RAHMAD PRISAL, LUBIS, ST

KEGIATAN

PERENCANAAN BANGUNAN
PANTI ANAK SIKALANG
(UPT PELAYANAN SOSIAL ANAK
SIKALANG (KABAN) AHE)

TAHUN ANGGARAN 2023

JUDUL GAMBAR

DETAIL POMPA &
TANGKI AIR

DI GAMBAR ADI PRATAMA 1

DIKERJAKAN SAFIUS M. HASAN 35

PEREKAMAN 35

SKALA 35

CAD FILE

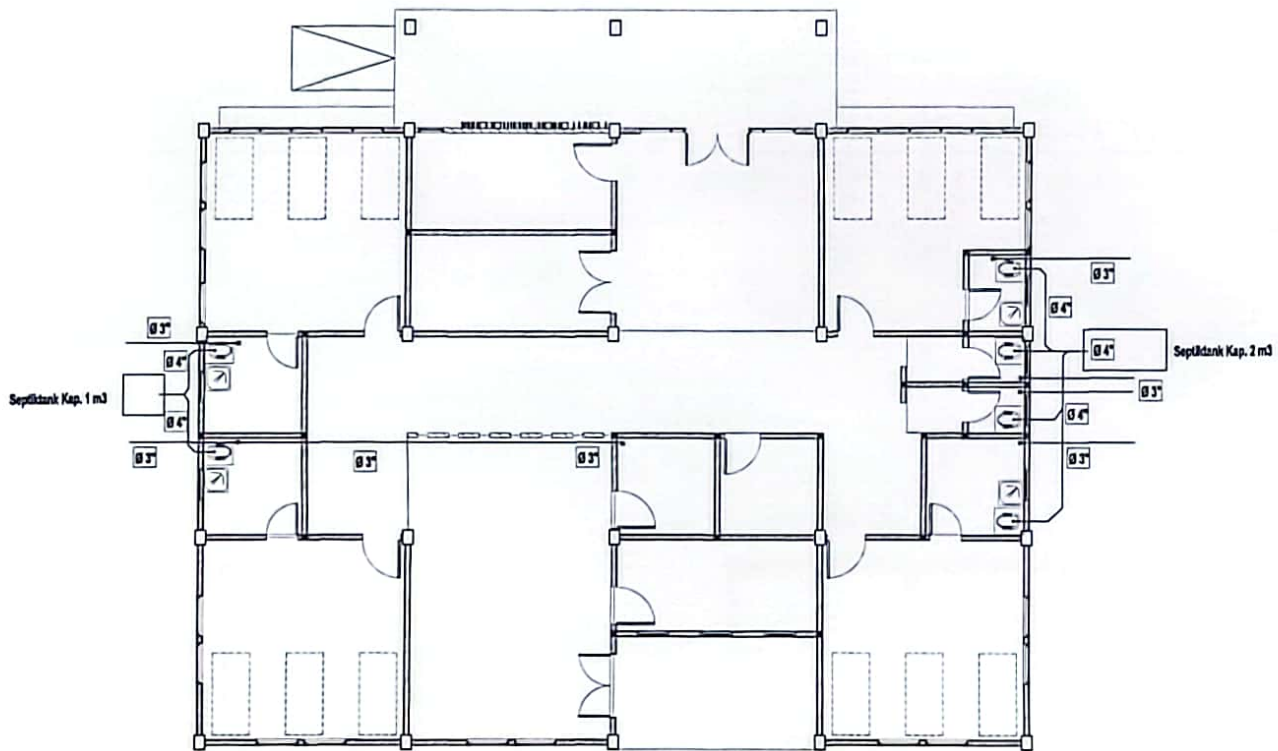

RENCANA AIR BEKAS & AIR KOTOR
 SKALA _____ NTS _____

KETERANGAN		
NO. TAWARAN	KETERANGAN	REVISI
PEMERINTAH KABUPATEN		
DINAS SOSIAL PROVINSI SUMATERA UTARA <small>UNIT PELAYANAN SOSIAL ANAK SINGKALANG KABUPATEN SIJUNJUNG</small>		
MENYETUJUI		
KEPALA DINAS SOSIAL PROVINSI SUMATERA UTARA		
<small>PELAKSANAAN PERENCANAAN</small> 		
MENGETAHUI		
PEJABAT PELAKSANA TEKNIK KEGIATAN		
<small>KAPALAKSANA TEKNIK KEGIATAN NIP. 1971 1229 200001 1 001</small> KONSULTAN PERENCANAAN		
TEAM LEADER		
<small>KONSULTAN PERENCANAAN</small> PERENCANAAN BANGUNAN FANTHIAN ANAK SINGKALANG (UNIT PELAYANAN SOSIAL ANAK SINGKALANG KABUPATEN SIJUNJUNG)		
TAHUN ANGGARAN 2023		
JUDUL GAMBAR		
RENCANA AIR BEKAS & AIR KOTOR		
<small>DIBANGUN</small> <small>DISERVISI</small> <small>DISETUJUI</small> <small>UNIT</small> <small>SKALA</small> <small>EAD FILE</small>	<small>ADY PRATIAMA</small> <small>SARUS M. HASAN</small> <small>PELITA BUANA</small> <small>UNIT</small> <small>SKALA</small> <small>EAD FILE</small>	

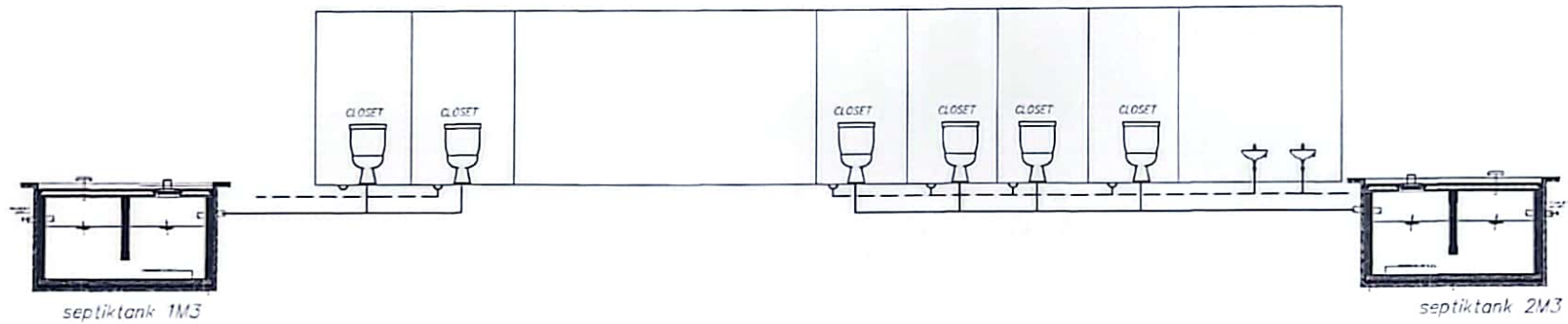
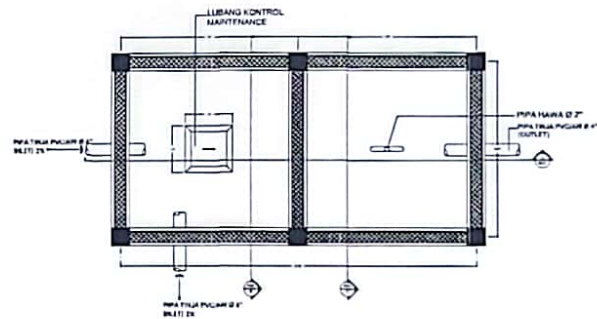
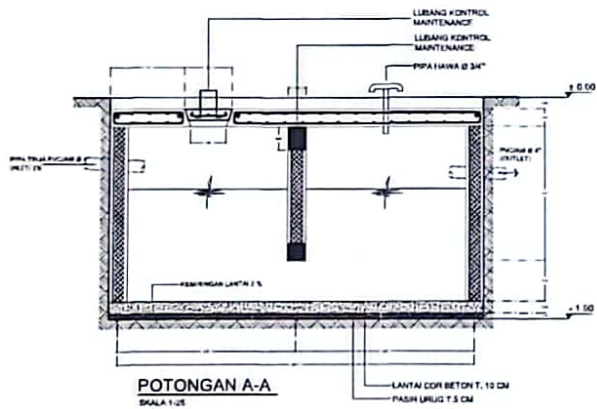

DIAGRAM INSTALASI PIPA AIR BEKAS DAN KOTOR
SKALA 1:15



DETAIL SEPTICTANK
SKALA 1:25

KETERANGAN
 ——— PIPA AIR KOTOR
 - - - - PIPA AIR BEKAS

KETERANGAN			
NO	TANGGAL	KETERANGAN	PARAF
REVISI			
PEMBERI TUGAS			
 DINAS SOSIAL PROVINSI SUMATERA UTARA UPT PELAYANAN SOSIAL ANAK SIDIKALANG-KABANJAH			
MENYETUJUI			
KEPALA DINAS SOSIAL PROVINSI SUMATERA UTARA			
UPT PELAYANAN SOSIAL ANAK SIDIKALANG-KABANJAH			
UPT PELAYANAN SOSIAL ANAK SIDIKALANG-KABANJAH			
NIP. 1971122-20091-1-001			
			
PEJABAT PELAKSANA TIENS KEGIATAN			
			
KARLETHONIUS SINAGA SH NIP. 1971122-20091-1-001			
KONSULTAN PERENCANA			
			
TEAM LEADER			
			
RAHMAT PRADYANUS ST			
KEGIATAN			
PERENCANAAN BANGUNAN PANTI ANAK SIDIKALANG (UPT PELAYANAN SOSIAL ANAK SIDIKALANG-KABANJAH)			
TAHUN ANGGARAN 2023			
JUDUL GAMBAR			
SKEMATIK PIPA AIR KOTOR, BEKAS DAN DETAIL SEPTICTANK			
DI GAMBAR	ADI PRATAMA	NOVEMBER	
DISERVISI	SAPULU M HASAN		
DISERVISI	UPT PELAYANAN		37
UNTUK			
SKALA			
CAD FILE			

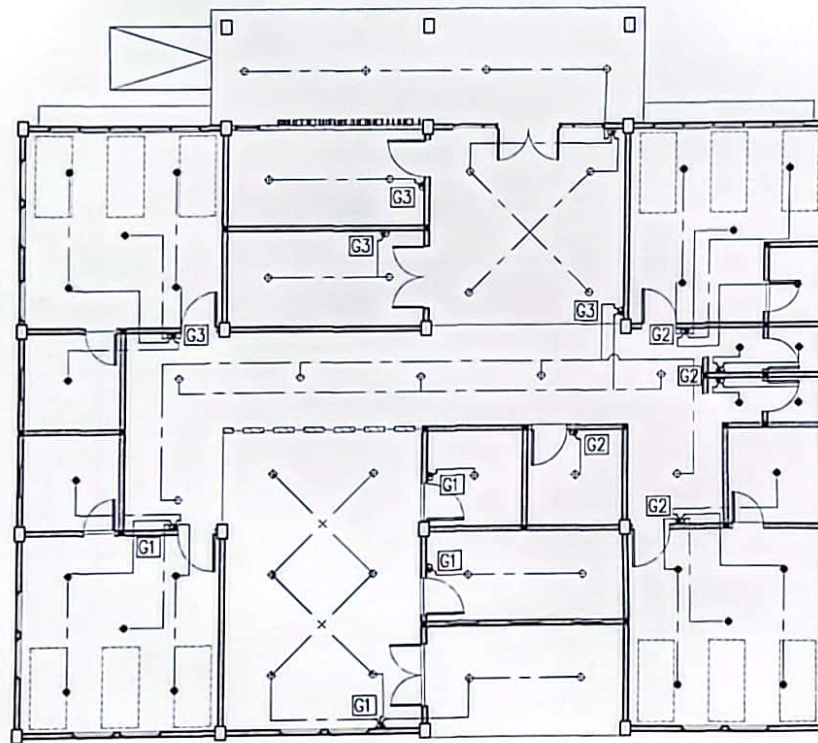

RENCANA TITIK LAMPU
SKALA NTS

- KETERANGAN**
- : LAMPU PLAFON BULAT PANEL LED 7 WATT
 - ⊙ : LAMPU PLAFON BULAT PANEL LED 13 WATT
 - ⏏ : saklar tunggal
 - ⏏⏏ : saklar ganda
 - ⏏⏏⏏ : saklar triple
 - ⏏⏏⏏⏏ : saklar cabang 4

KETERANGAN

NO	TANGGAL	KETERANGAN	PIRUP
REVISI			
PEMERIKSA TUGAS			
 DINAS SOSIAL PROVINSI SUMATERA UTARA <small>UPD PELAYANAN SOSIAL ANAK</small> <small>DIKALANG KABANJAH</small>			
MENYETUJUI			
KEPALA DINAS SOSIAL PROVINSI SUMATERA UTARA			
<small>DR. HILMAN PRINILAKA HATI S. S. S. M. S.</small> <small>197102020011001</small>			
			
MENGETAHUI			
PEMANGKUL PELAKSANAAN KEGIATAN			
 <small>PRAMONO Sihaloho</small> <small>NIP. 19711228 200801 1 001</small> <small>FONSULTAN PERENCANAAN</small>			
 CV. PELITA BUANA <small>PT. PERUMAHAN SIBOLGA</small> <small>PT. PELAYANAN SOSIAL ANAK</small> <small>DIKALANG KABANJAH</small>			
TEAM LEADER			
 <small>Fauzad Zebadi</small> <small>19850901199001001</small>			
KEGIATAN			
<small>PERENCANAAN BANGUNAN</small> <small>PANTI ANAK SIBOLGA</small> <small>(UPD PELAYANAN SOSIAL ANAK</small> <small>DIKALANG KABANJAH)</small>			
TAHUN ANGGARAN 2023			
JUDI.E. GAMBAR			
RENCANA TITIK LAMPU			
DI GAMBAR	ADI PRATAMA	30	
DI PERIKSA	SATU M. HASAN	30	
DI PERIKSA	JANTI	30	
SKALA		30	
CAD FILE			

SDP

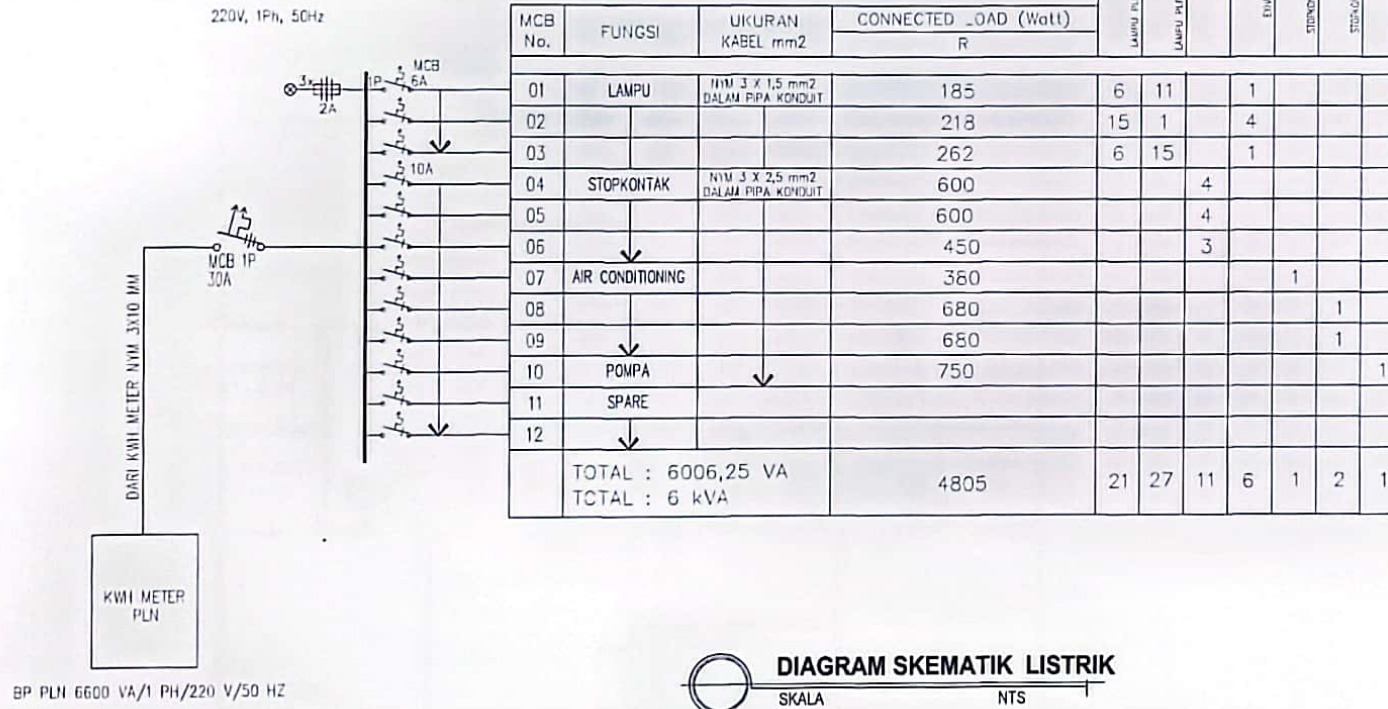

DIAGRAM SKEMATIK LISTRIK
SKALA _____ NTS

KETERANGAN

NO. TANGGAL: _____ KETERANGAN: _____ PERUBAH: _____

REVISI

PEMBERI TUGAS

DINAS SOSIAL PROVINSI SUMATERA UTARA
UPT PELAYANAN SOSIAL ANAK SIKALANG KABANGKALAH

MENYETUJUI

KEPALA DINAS SOSIAL PROVINSI SUMATERA UTARA

ZULI SURIANI P. PINAMAHATI S.Si, Apt, M.Si
NIP. 19710210012001001

KABUPATEN SINAGA
UPT PELAYANAN SOSIAL ANAK SIKALANG KABANGKALAH
DEWY ELOSARAYAN S.Si
NIP. 198702210031003

MENGETAHUI

PEJABAT PELAKSANA FUNGSI KEGIATAN

[Signature]
KARLETONUS SINAGA TH
NIP. 19710210012001001

KONSULTAN PERENCANA

C.V. PELITA BUANA

TEAM LEADER

[Signature]
RAHMASTUTI LUBIS ST

KEGIATAN

PERENCANAAN BANGUNAN PANTI ANAK SIKALANG (UPT PELAYANAN SOSIAL ANAK SIKALANG KABANGKALAH)

TAHUN ANGGARAN 2023

JUDUL GAMBAR

DIAGRAM SKEMATIK LISTRIK

DI GAMBAR: ADI PRATAMA
DIPERIKSA: SUPUL M. HASAN
PELAKSANA: _____
SKALA: _____
CAD FILE: _____

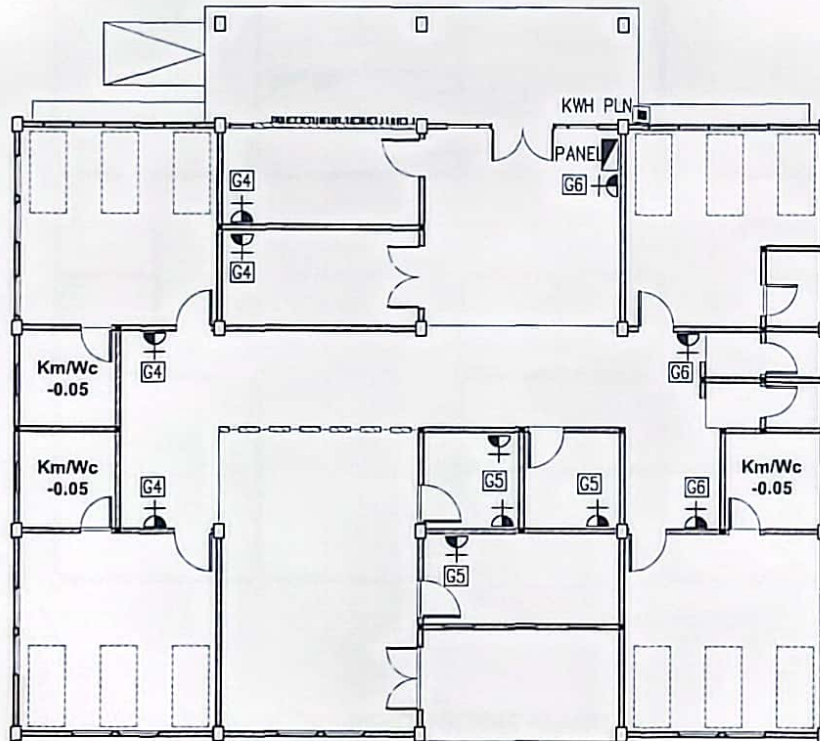

RENCANA STOP KONTAK
 SKALA NTS

KETERANGAN

: stop kontak dinding

KETERANGAN

NO	TANGGAL	KETERANGAN	REVISI

REVISI

PEMBERI TUGAS

**DINAS SOSIAL
 PROVINSI SUMATERA UTARA**
 UPT PELAYANAN SOSIAL ANAK
 SIDIKALANG KABUPATEN

MENYETUJAI

KEPALA DINAS SOSIAL
 PROVINSI SUMATERA UTARA

DI SUSUN OLEH: **PELITA BUANA**



PELAKSANAAN KEGIATAN

HARLETHA SUSI SIHAGA SM
 NIP. 1971028 200801 1 001
 KONSULTAN PERENCANA

CV. PELITA BUANA

TEAM LEADER

FAHMAD HIDAYAT LUBIS ST

KEGIATAN
 PERENCANAAN BANGUNAN
 PANTI ANAK SIDIKALANG
 (UPT PELAYANAN SOSIAL ANAK
 SIDIKALANG KABUPATEN)

TAHUN PENGGAJIAN 2023

JUDUL GAMBAR

RENCANA STOP KONTAK

DI GAMBAR OLEH: **PELITA BUANA**

DISERVISI OLEH:	SAFELI M. HASAN
PERENCANAAN:	
SKALA:	
CAD FILE:	

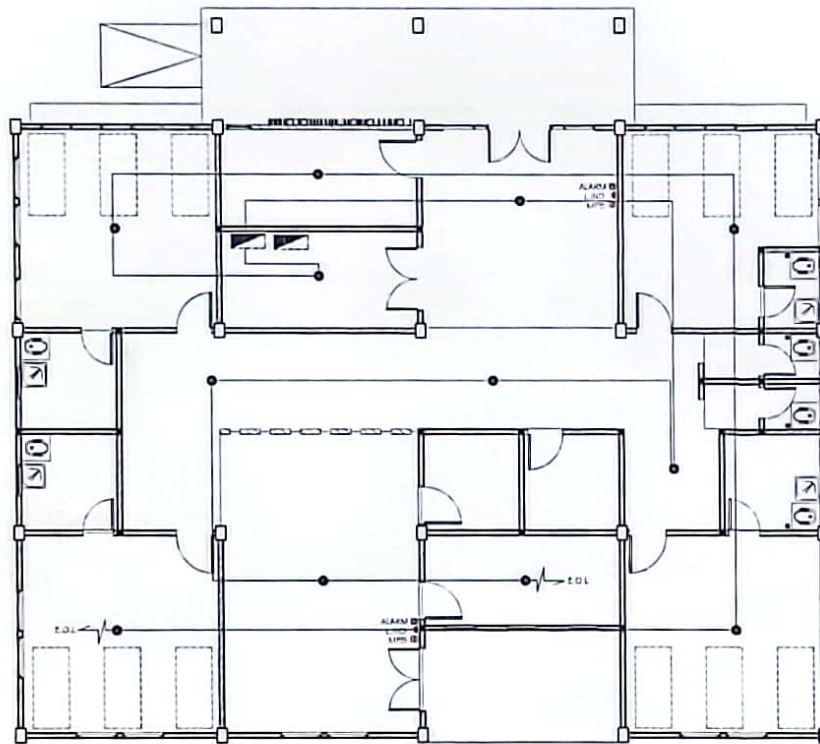

RENCANA FIRE ALARM
 SKALA NTS

- KETERANGAN**
- ☉ : Smoke detector
 - 🔔 : Alarm Bell
 - 📢 : Lampu Indikator
 - 👉 : Manual push button
 - 🔲 : Master control fire alarm (MCFA)
 - 🔲 : Annunciator
 - E.O.L. — : End of line

KETERANGAN		
NO	TANGGAL	KETERANGAN
PEMBERI TUGAS		
 DINAS SOSIAL PROVINSI SUMATERA UTARA <small>UNIT PELAYANAN SOSIAL ANAK</small> <small>SOSIALKALANG-KABANGJAHJE</small>		
MENGETAHUI		
KEPALA DINAS SOSIAL		
PROVINSI SUMATERA UTARA		
<small>DR. SURGAN PURNAMA RATI S. SI. Ag. M. Si.</small> <small>NIP. 19710211981031001</small>		
		
MENGETAHUI		
PELAKSI KEKELAKSANAAN KEGIATAN		
 <small>KARLA FIRDAUSY ETNAGA SIH</small> <small>NIP. 1971122198811001</small>		
KONSULTAN PERENCANA		
		
TEAM LEADER		
 <small>RAHMAD ZUHRI LUBIS</small>		
KEGIATAN		
PERENCANAAN BANGUNAN PANTI ANAK SIDIKALANG (UPT PELAYANAN SOSIAL ANAK SIDIKALANG-KABANGJAHJE)		
TAHUN ANGGARAN 2023		
JUDUL GAMBAR		
RENCANA FIRE ALARM		
DI GAMBAR	ACE PRATIAMA	
DIPERIKSA	SAIFUL M. HASAN	
DITOLAK		
DITOLAK		
SKALA		41
CAD FILE		

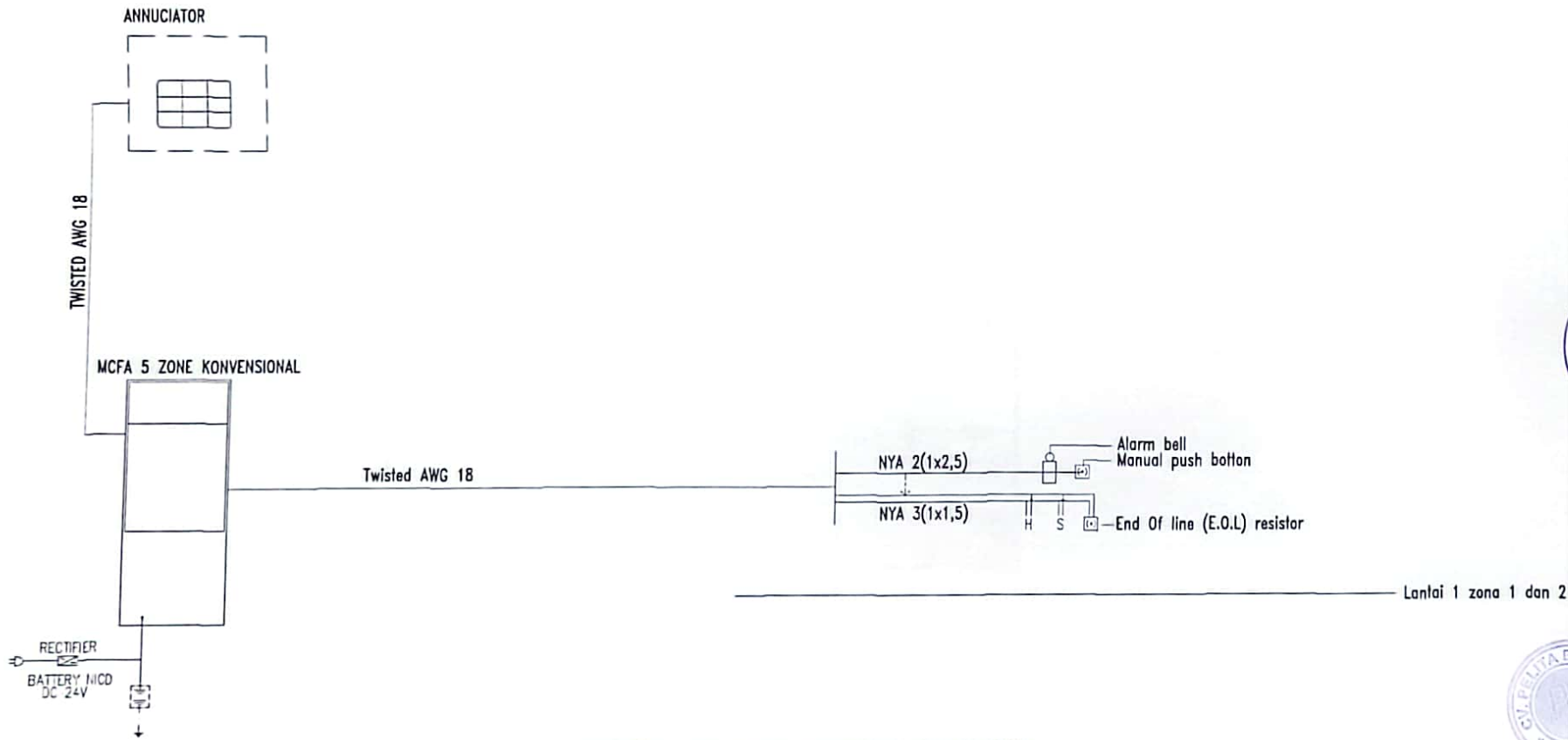
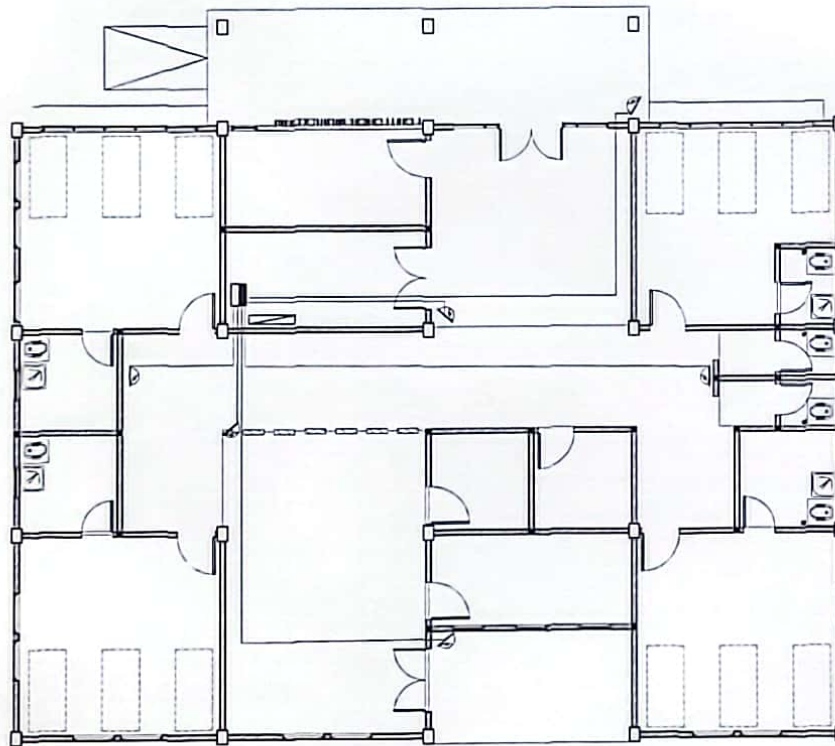





DIAGRAM SKEMATIK FIRE ALARM
 SKALA NTS

KETERANGAN		
NO	REVISI	REVISI
PEMERIKSA TUJAS		
 DINAS SOSIAL PROVINSI SUMATERA UTARA <small>UPA PELAYANAN SOSIAL DAN</small> <small>KEPERAWATAN JALAN</small>		
MENYETUJUI		
KEPALA DINAS SOSIAL PROVINSI SUMATERA UTARA		
DRI SURABANG PURNANAWATI S.Si, Apt M.Si		
NIP. 1963080119813001		
		
MENYETUJUI		
PEJABAT PELAKSANA TEKNIK KELOMPOK		
 KARLETHA LUS SIHAILA SH <small>NIP. 19711228 2003011 001</small> KONSULTAN PERENCANAAN		
		
TEAM LEADER		
 Rafraf KONSULTAN PERENCANAAN		
KEGIATAN		
PERENCANAAN BANGUNAN PANTI ASIAK SIKALANG (SUPT PELAYANAN SOSIAL ANAK SIKALANG-KABANJAH)		
TAHUN ANGGARAN 2023		
A/DIIL GAMEAR		
DIAGRAM SKEMATIK FIRE ALARM		
DI GAMBAR	ADI PRATAMA	1:10000
DISERIKSI	SAPULU M. HASAN	42
PEREKAM	UNTUK	
SKALA		
CAD FILE		



RENCANA CCTV
 SKALA NTS

KETERANGAN

 : CCTV 2 MP
 : MONITOR LED
 : DVR

KETERANGAN		
NO	TANGGAL	REVISI
PEMBERI TUGAS		
 DINAS SOSIAL PROVINSI SUMATERA UTARA <small>UPT PELAYANAN SOSIAL ANAK SIKOLANG (KABANJAH)</small>		
MENYETUJUI		
<small>KEPALA DINAS SOSIAL PROVINSI SUMATERA UTARA</small>		
<small>PELAKSANAAN</small> 		
<small>PEJABAT PELAKSANAAN KEGIATAN</small> <small>(PPTK)</small>  <small>KAPAL UPT PELAYANAN SOSIAL ANAK SIKOLANG (KABANJAH)</small> <small>NIP. 14711228 202001 1 001</small> <small>KONSULTAN PERENCANAAN</small>		
 CV. PELITA BUANA <small>Perencana dan Konsultan</small>		
TEAM LEADER		
 <small>RAHMAT HUSAINI S.T</small> <small>KEGIATAN</small>		
<small>PERENCANAAN BANGUNAN PANTI ANAK SIKOLANG (UPT PELAYANAN SOSIAL ANAK SIKOLANG (KABANJAH))</small>		
TAHUN ANGGARAN 2023		
JUDUL GAMBAR		
RENCANA CCTV		
DI GAMBAR	ADI PRATAMA	<small>REVISI</small>
DI PERIKSA	SAFUL MAHALAN	<small>REVISI</small>
PERIKSAAAN		
UNIT/KE		
SKALA		
CRD FILE		

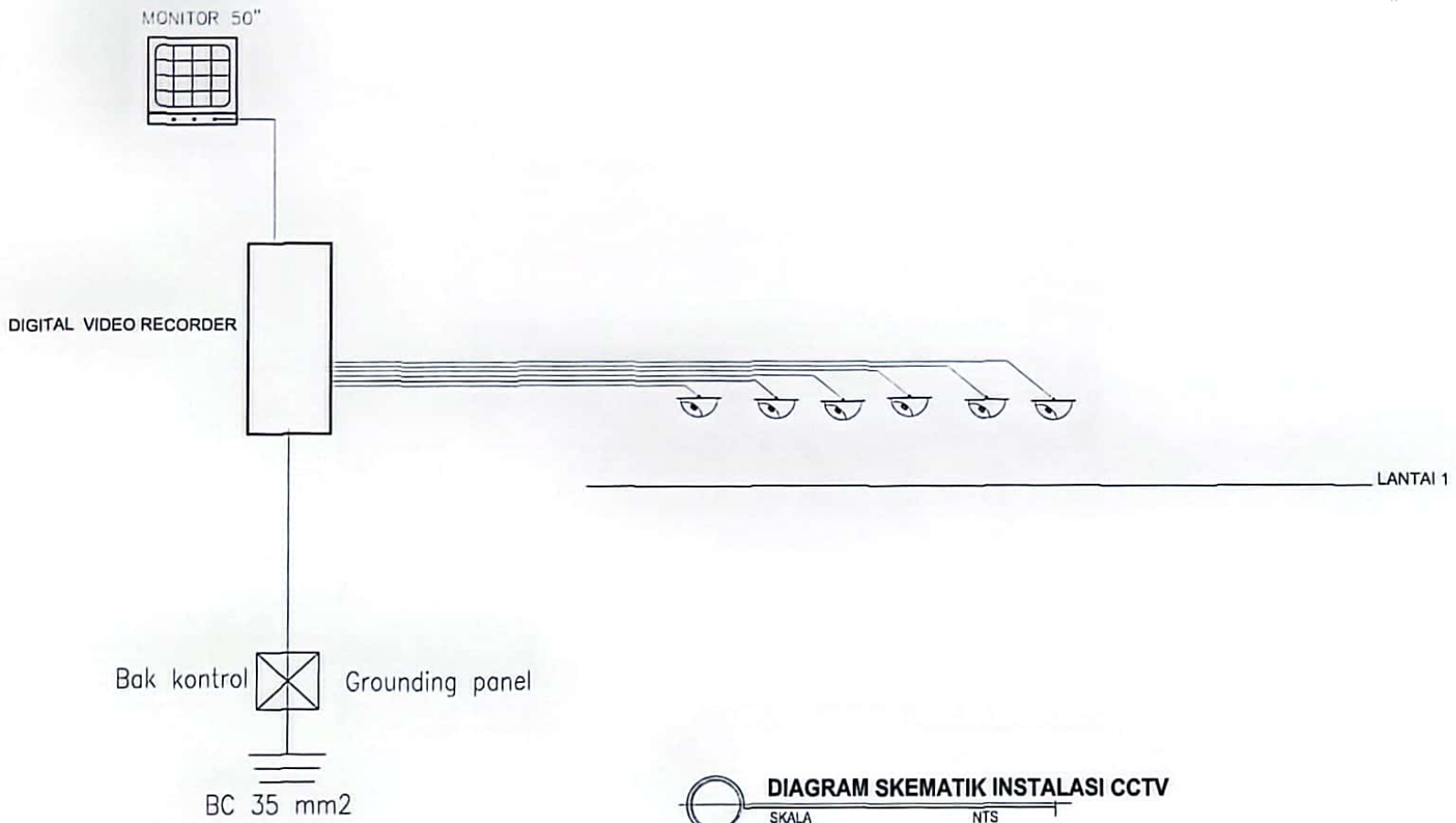

KETERANGAN		
NO	TAMBAHAN	REVISI
PEMERIKSA TUGAS		
 DINAS SOSIAL PROVINSI SUMATERA UTARA UPT PELAYANAN SOSIAL ANAK SIKOKALANG KABARAJAHE		
MENYETUJUI		
KEPALA DINAS SOSIAL PROVINSI SUMATERA UTARA		
		
MENYETUJUI		
PEKERJA PELAKSANA TEKNIK KEGIATAN		
 KARELITO SIBUS SINADALIN NIP. 19711228 200311 1 001 KONSULTAN PERENCANAAN		
		
TEAM LEADER		
 FAHMAD KEGIATAN		
PERENCANAAN BANGUNAN PANTI ANAK SIKOKALANG (UPT PELAYANAN SOSIAL ANAK SIKOKALANG KABARAJAHE)		
TAHUN ANGGARAN 2023		
JUDUL GAMBAR		
DIAGRAM SKEMATIK INSTALASI CCTV		
DI GAMBAR OLEH	AD PRATAMA	
DISERIKSA OLEH	SAFUL M HANAN	
PEREKAM LANTAI		
SKALA		44
CAD FILE		

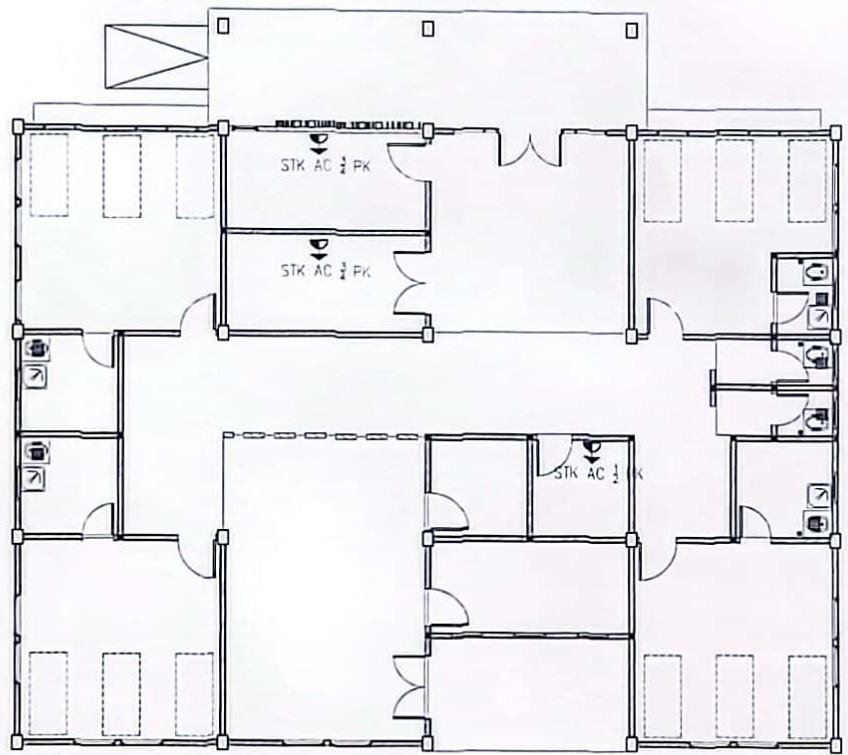

KETERANGAN

 : Ceiling Exhaust fan
 : Stopkontak Air conditioning

RENCANA TATA UDARA
 SKALA _____ NTS _____

KETERANGAN

NO	TANGGAL	PETERANGAN	PISAH
REVISI			
PEMBERI TUGAS			
 DINAS SOSIAL PROVINSI SUMATERA UTARA <small>UPT PELAYANAN SOSIAL ANAK SIKALANG KASANJAHJE</small>			
MENYETUJUI			
<small>KEPALA DINAS SOSIAL PROVINSI SUMATERA UTARA</small>			
			
PELABAT PELAKSANA TIJIDUS KEGIATAN			
 <small>KARLES SIMANIS SINAGAH NIP. 1971122 20091 1 001</small>			
KONSULTAN PERENCANA			
			
TEAM LEADER			
 <small>RAHMAD ZHANG</small>			
KEGIATAN			
<small>PERENCANAAN BANGUNAN PANTI ANAK SIKALANG (UPT PELAYANAN SOSIAL ANAK SIKALANG KASANJAHJE)</small>			
TAHLUN ANGGARAN 2023			
JUDUL GAMBAR			
RENCANA TATA UDARA			
DI GAMBAR	ADI PRATAMA		
DIPERIKSA	SAPULU M. HASLAN		
PERENCANAAN			
UNIT/LE		45	
SKALA			
CAD FILE			